

## College of Agriculture and Life Sciences Extension Publications

---

The Extension Publications collections in the UA Campus Repository are comprised of both current and historical agricultural extension documents from the College of Agriculture and Life Sciences at the University of Arizona.

**This item is archived to preserve the historical record. This item may contain outdated information and is not intended to be used as current best practice.**

Current extension publications can be found in both the UA Campus Repository, and on the CALS Publications website, <http://cals.arizona.edu/pubs/>

If you have questions about any materials from the College of Agriculture and Life Sciences collections, please contact CALS Publications by sending an email to: [pubs@cals.arizona.edu](mailto:pubs@cals.arizona.edu)

---

# YOUR ROOM

a 4-H project for boys & girls



Circular 248

Agricultural Extension Service  
University of Arizona, Tucson

## This Is What You Do In The Project

- ☆ Learn to demonstrate
- ☆ Practice judging in your club
- ☆ Keep records
- ☆ Exhibit what you make

### These are Your Requirements

1. **Learn about color**  
Choose and use colors all in one family or in simple contrast of one or two colors.
2. **Make Room Furnishings**  
(elective for boys)  
Make a hand towel, a guest towel or a dresser scarf or mat.
3. **Make Storage Items**  
Make two items from the lists on pages 14 to 17.

#### 4. Learn About Light

Learn to know kinds of bulbs for good light.

#### 5. Keep Your Room Neat

Sweep or clean floor once a week. Dust room twice each week. Make a dusting mitten. Make your bed or help make it daily.

### Here are Your "Extras"

- ☆ Make a picture or choose a frame for one.
- ☆ Make extra towels or scarf.
- ☆ Make extra storage items from list on pages 23 to 25.

## Be A "Regular" Club Member

A regular club member demonstrates ideas learned in club work. To "demonstrate" means to talk and show how at the same time. Search your room-improvement requirements for interesting demonstrations. Ask your leader for suggestions. Here are some ideas to set you thinking:

### Demonstrations You Can Do

- Color In My Room
- Neat Corners For Hems
- Choosing Material For Towels
- How To Hemstitch
- Interesting Storage (use any items on storage list)

- Making A Dusting Mitten
- Using A Dusting Mitten
- Making A Bed
- How To Make And Use A Sanding Block
- Framing A Picture
- Dividing Drawer Space
- Good Light In My Room (bulbs only)
- How To Judge (use any article you made)

---

*University of Arizona  
College of Agriculture  
Agricultural Extension Service  
Chas. U. Pickrell, Director  
Cooperative extension work in agriculture and home economics, the University of Arizona College of Agriculture and the United States Department of Agriculture cooperating. Distributed in furtherance of the Acts of Congress of May 8 and June 30, 1914.  
3M—September 1956—Circular 248*

## Take Part in An Achievement Day

You can help club work grow by taking your Room Improvement articles to an Achievement Day or a County Fair. Check each item before you send it, by asking yourself these questions:

1. Is it clean, pressed, and neat?
2. Did I follow directions in my book?

3. Are my name, address, and the name of my club on each piece?

## Keep Records

Records give a picture of your club work. You will find record sheets on Pages 9, 10, 27, 28. When you finish your project cut out these pages to hand in as your record on Achievement Day or whenever your leader wishes them.

## Contents

	Page		Page
What You Will Do - - - -	2	Dress Up Your Room - - - -	7
Demonstration - - - -	2	Learn to Judge - - - -	14
It's Your Room - - - -	4	A Place to Store Things - - -	14
Plan Before You Start - - -	5	Pictures Will Help Your Room -	19
Keep Your Records - - - -	6	How Is The Light In Your Room-	19
Use Your Favorite Colors - - -	6	Make Your Room Shine - - -	20
		"Extras" For Your Room - - -	23

\* This is a publication of the Agricultural Extension Service, University of Arizona. See your local County Agricultural Agent or County Home Agent for other farm and home information.

# YOUR ROOM

By

Grace Ryan

Extension Specialist in Home Management  
University of Arizona, Tucson

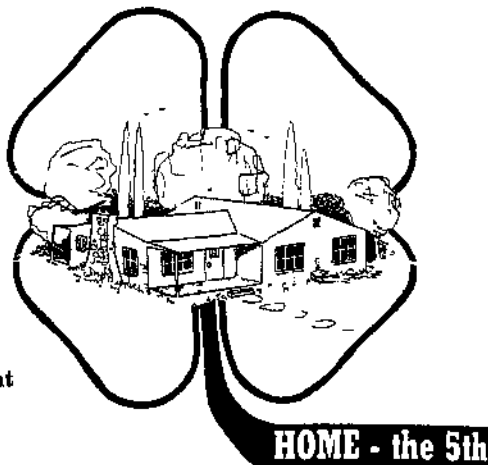

“Improve Your Room” is a 4-H home-improvement project. The “H” for home deserves an important place among 4-H projects. You might say it’s the 5th “H.” This

project is for any 4-H member who wants to make a room attractive, comfortable, and convenient. It is for boys as well as girls.

## It’s Your Room!

The part of the house you call your own is very important. A boy would surely appreciate a chance to use his own ideas about his own room.

A girl’s ideas of decoration may differ from a boy’s. This project gives each of you a chance to make a room attractive according to your own plans.

### For Boys

A boy’s room needs to be convenient and very easy to clean. Perhaps special storage is the big item. Certainly a room that makes it easy for you to keep clothes neat and in good shape, shoes in good order,

and shirts and socks where you can find them should be of interest to you.

Your accomplishments can be:

- Good use of strong colors.
- Two wood storage items (such as shoe racks, shoe polishing box, etc.)
- Correct light bulbs for your room.
- Well made bunk or bed.
- “Extras” if you wish, such as your favorite picture, well framed; or a hobby board; or additional storage items for your family.

## For Girls

You may find all of the requirements suitable for your room, but may decide that storage items which require wood work do not interest you. You may do "extras" if you choose.

YOUR list of accomplishments may look like this:

- A color scheme using your favorite color, or colors, in dresser covers or towels.
- Any two items of storage, including wooden articles if you wish.
- Correct light bulbs.

- Bed making.
- "Extras" if you wish, such as pictures, guest towels, etc.

## Improve Your Room

Improving your room is like building a house. For the foundation you need blocks to be used over and over again as you add to your room-improvement project. By noticing their names you will soon know the blocks by heart because no room can be without them.

In this project you will "build" with **color**, **room care**, **storage**, and **lighting**. (See drawing below.)

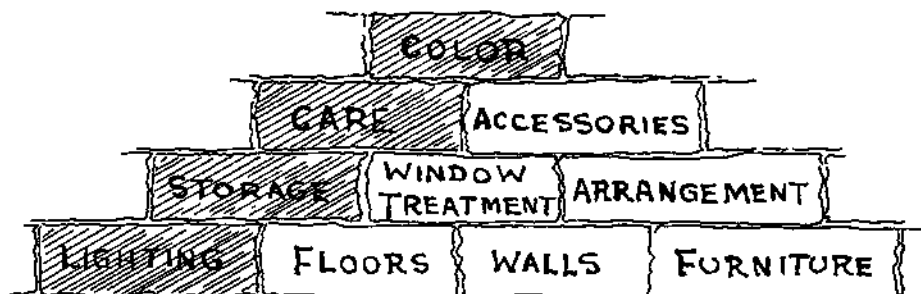

These are your "building blocks" for room improvement.

## Plan Before You Start

It is always a good idea to plan changes and decide how to make them before you begin work in a room. In this way you save time and disappointment. Here are a few ideas for planning:

Talk things over with your parents.

Get your partner's ideas (if you share a room).

List what you now have in your room.

Check the colors you now use. Decide on improvements for the room.

Count the cost.

Begin with simple changes.

Choose work you are sure you can do.

# Keep Your Records

After you have thought about and talked about your plans, fill out page 9. This is part of your club record and can be clipped from your book when your leader asks for records at the end of the club

year. So be neat and accurate.

Records give a picture of your club work. Be sure to keep them as you go along in the pages of this book. These records are on pages 9 and 10, and also on pages 27 and 28.

## Use Your Favorite Colors

Color is a very important building block in room improvement. It is an interesting one, too. There is much you could learn about color, but let us make a simple start with a few easy facts. There will be plenty of time for more ideas as you go along in home-furnishing projects.

Begin by reviewing what you have learned about color in art classes at school. Circle "A" tells the names of "primary" colors which are the three colors from which all others can be made. They are red, blue, and yellow.

Circle "B" shows new colors made when you "add" equal parts of one primary to another. The new are called "secondaries" and are named orange, green, and violet.

You know the colors of the rainbow. Imagine them in a circle like this. (See below). The circle will help you choose room colors.

You may make a plan to use light and dark members of a color family. The shaded areas below show such a group. If green is your

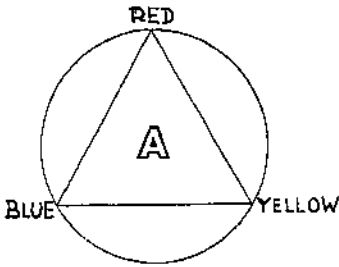

Here are the Primary Colors.

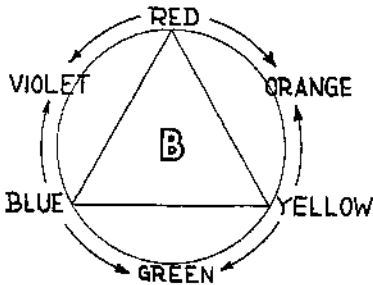

The Secondary Colors are Violet, Orange, and Green.

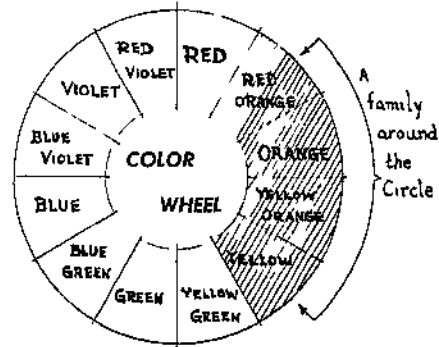

Related colors are of the same "family."

favorite, use several shades in that color. Or use blue, or yellow.

Or try your favorite with an "opposite" shown at right.

By using either plan you have a simple "color harmony" to make your room more attractive. Use small amounts of bright colors.



**Opposite colors show harmonious contrast.**

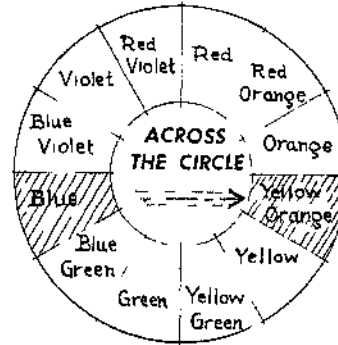

## Dress Up Your Room

You can dress up your room with interesting articles such as scarfs, towels, storage items, and good lights. These are included as club requirements (See page 2). Make other attractive items which are listed as "extras."

Some of these "dress-up" articles have handmade touches which add color and interest. Choose and make one article from this list:

- Hand towel.
- Guest towel.
- A pair of finger-tip towels.
- A fringed or hemmed cover for a dresser or chest of drawers.

We have grown away from towels and scarfs of white with much lace or heavy embroidery. Now we plan to make articles which are:

- Gay and colorful.
- Simple in line and design.
- In harmony with other articles in the room.
- Easy to make, to wash, and to iron.

Colored towels and scarfs are very fashionable, and color can be a decoration in itself. You will find flowered, striped, and plain materials in many weaves and colors.

### Materials To Select For Towels Or Scarfs

Hand Towel	Guest Towel	Finger-tip Towel	Scarfs
Woven toweling (with selvage)	Same as hand towels but of better quality	Linen	Gingham
Linen (yardage)		Indian Head	Percalé
Crash		Butcher's Rayon	Indian Head
Butcher's Rayon			Poplin
Indian Head			Cretonne
			Swiss
			Drapery Material
			Marquisette
			Cotton dress prints



## Kinds and Sizes of Towels and Scarfs

You may make towels for your own use or for use by guests. "Hand" towels are everyday ones, usually plain and sturdy, while "guest" towels are smaller and often embroidered. "Finger-tip" towels are guest towels, still smaller in size.

When you make a choice of an article from the list on page 7 be sure you understand its size, because size will be your guide to **buying** material. Here are the usual amounts to **buy**:

Hand towel - **Allow** 30 inches length and 19 to 20 inches width.

Guest towel - **Allow** 24 inches length and 13 to 14 inches width.

Finger-tip towel - **Allow** 18 inches length and 10 to 12 inches width.

A dresser scarf has no set size. A scarf covers poor wood or leaves 1-½ to 2 inches of good wood showing on all sides. So, measure the scarf to cover your own dresser.

Drawings on page 11 tell you the **finished** size of towels and scarfs.

## Cut Fabric Carefully

Check measurements of towels and scarfs carefully before you cut your fabric. Pull a thread on the grain line to guide you in cutting. Or, if you use coarse toweling, cut along a thread without pulling it. Straighten the cut pieces before hemming by pulling diagonally from corner to corner.

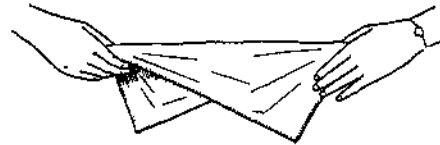

A diagonal pull straightens the "grain" of the cloth.

## Hem and Trim Corners

Before you sew, learn to do a regular hemming stitch and practice it. Household hems need strong, small stitches to wash well.

The picture below shows regular hemming stitches.

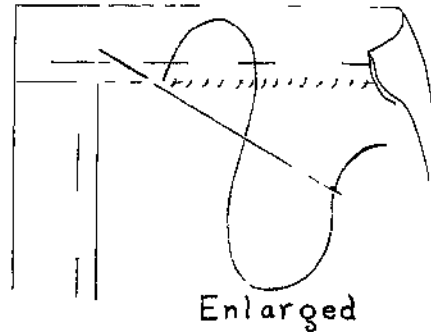

This hemming stitch differs from a stitch used on a dress hem.

Now notice that the drawing below shows how to cut the corners of hems before basting the hems.

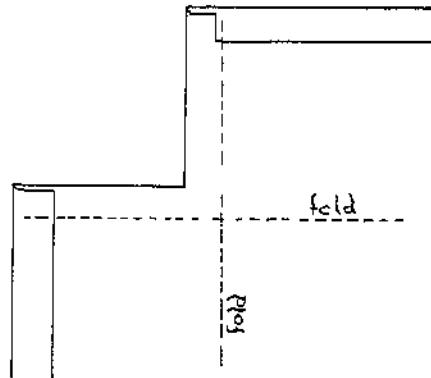

Avoid "bumpy" corners by cutting away extra cloth in a miter like this.

# Room Improvement Record No. 1

## Tell About Your Room

My room is on the \_\_\_\_\_ side of the house.  
north, east, south, west

The wall finish is \_\_\_\_\_  
paint, wood, wallpaper, plaster, etc.

The floor is \_\_\_\_\_  
concrete, wood, tile, etc.

Colors in my room are:

Walls \_\_\_\_\_

Floor \_\_\_\_\_

Furniture \_\_\_\_\_

Curtains \_\_\_\_\_

Extra Items \_\_\_\_\_

I have this furniture: (example—chairs, dresser, etc).

\_\_\_\_\_  
\_\_\_\_\_  
\_\_\_\_\_  
\_\_\_\_\_

I plan to make the following changes: (example—improve storage,  
add color, etc.) \_\_\_\_\_

\_\_\_\_\_  
\_\_\_\_\_  
\_\_\_\_\_  
\_\_\_\_\_

(Record Sheet—To be cut out when needed.)

## Room Improvement Record No. 2

### Show Your Color Plan

Use a crayola or small pieces of paper or cloth in the spaces below to show the color FAMILY or contrast you used in your project.

I used these colors:

Name of color family \_\_\_\_\_

Name of "contrasting" color \_\_\_\_\_

(Example—Indicate your colors here).

--	--	--	--

I chose color for these articles: (check  )

Scarf or towels \_\_\_\_\_

Picture \_\_\_\_\_

Storage items \_\_\_\_\_

Other articles \_\_\_\_\_

## Make Towels or Scarfs

You need only one simple set of rules for hemming any article on the list. The sizes of hems differ but the method of turning, basting, and hemming is the same.

Study the drawings below on this page. They show sizes of hems for each article. When using toweling with selvages, no side hems are needed.

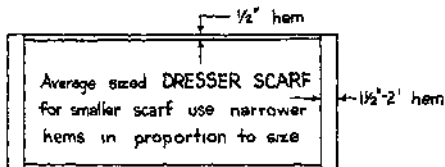
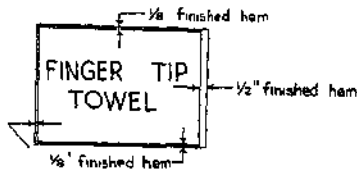
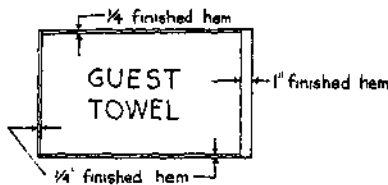
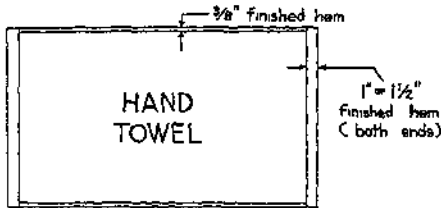

## Turning Hems

Measure and turn all hems as follows:

1. Fold first turn on the lengthwise thread for side seams. Use  $\frac{1}{4}$  inch for larger towels and for dresser and chest scarfs. Use about  $\frac{1}{8}$  inch for small towels.

2. Baste this first turn of the hem.

3. Make the second turn. Consult the drawings at the left for proper sizes.

4. Pin the second turn of the hem in place with pins standing perpendicular to the hem. Do not baste until you have cut away extra cloth by the method described in Step 5.

5. Open this hem near the end and cut extra cloth out as shown in diagram bottom of page 8. This cut is **NOT** a true miter or triangular cut. The corner remains **RECTANGULAR**.

6. Fold the hem back in place, pin, and baste.

7. Fold the end hems as you have folded the sides—first  $\frac{1}{4}$  inch on large towels and  $\frac{1}{8}$  inch on small ones—then the second larger turn. The amount turned depends on the size of the article. **Don't forget** to check the drawings for size (Page 8).

8. Baste. Hem all sides with matching thread. (See center drawing, page 8).

9. Overhand the ends of the hems  $\frac{1}{8}$  inch to  $\frac{1}{4}$  inch above the hem. Hems will iron more smoothly when end hems are partly open, but small hems on the smaller towels may need to have the entire end closed to prevent raveling.

## You May Wish To Hemstitch

If you hemstitch the ends of a scarf or larger towel, follow these steps:

1. Mark the width of the hem. Draw threads along this marking for a row of hemstitching. The number of threads drawn depends upon the width of hemstitching you wish.

2. Turn and baste hems as for regular hemming stitches.

3. Hold the folded edge of the hem toward you and with matching thread catch the threads in groups as shown below. The threads

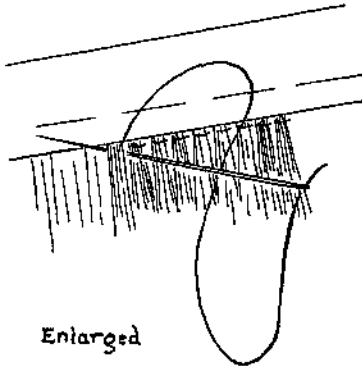

Note that the needle is separating the threads of the cloth into groups.

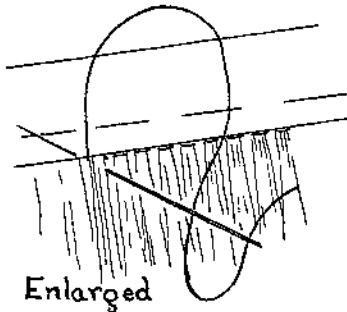

After the needle separates the threads, a second stitch catches the hem.

caught in each group usually equal the number of threads drawn.

## Fringed Edges

Fringed edges are simple if you can do machine stitching well. Boys who want covers for chests of drawers will find fringed scarfs easier to make.

Steps in fringing are:

1. Plan the size of the article, measure carefully, and allow  $\frac{3}{4}$  inch to 1 inch for fringing on all sides of a scarf or on the ends of fringed finger-tip towels.

2. Cut the fabric carefully (see page 8).

3. Draw a thread  $\frac{3}{4}$  to 1 inch from the 4 edges of the scarf. Set the machine for 12 to 14 stitches per inch. Begin  $\frac{1}{4}$  inch from any corner and stitch just inside the drawn thread on all 4 sides. The dotted line shows you how to stitch in a CONTINUOUS line around the square or oblong. Finish by stitching  $\frac{1}{4}$  inch beyond the point where you began. (see below)

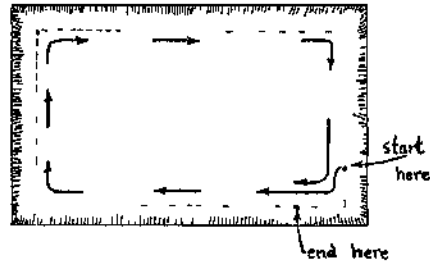

Machine stitch the fringed article.

4. Pull threads up to the stitching line to make fringe. Trim the fringed threads neatly.

5. Some prefer to overhand along the machine stitching by hand before raveling the fringe. This makes a stronger edge.

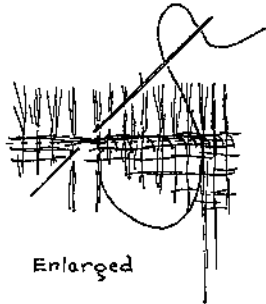

Use an overhand stitch along the fringed edge.

## Do Embroidery If You Wish

Does embroidering interest you? If so you may decide to decorate towels or scarfs. Simple stitches are best. So are simple designs in one or two colors. Drawings below show three simple stitches easy to make and suitable for your 4-H project.

Remember that good embroidery work shows no knots, no loose ends or long skips on the wrong side. It should be neat and attractive.

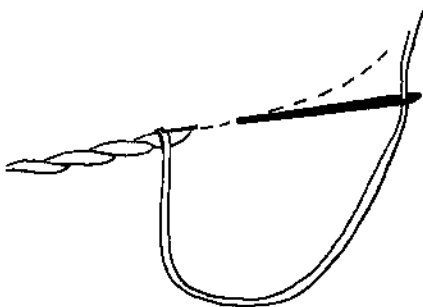

Use the outline stitch for designs and long end hems.

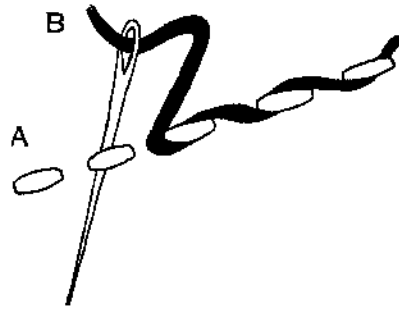

The couching stitch also is a hem decoration.

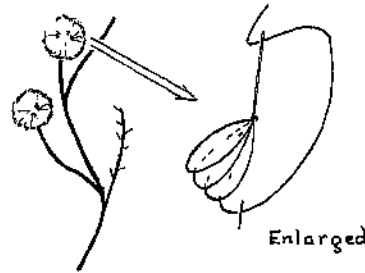

Pin-wheel stitches are suitable for guest and fingertip towels.

## Stenciled Designs

You may wish to stencil a simple design on a towel or scarf. Place it along hand-stitched or fringed end hems.

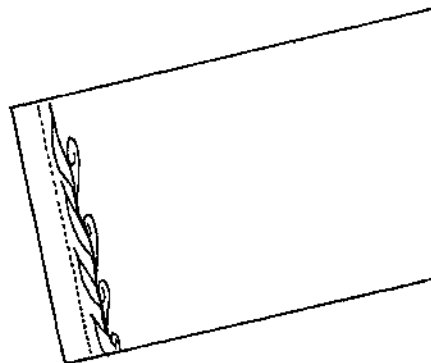

You may use a simple stencil design across ends.

# Learn To Judge

Judging can be scoring your own work or it can be learning to compare several articles made by the same directions or rules. Judging is really just learning to make up your mind and to give reasons for what you think.

Try your judging skill on this scorecard for the hemmed article you made.

## Are You Satisfied?

### Material

Is the material washable and easy to iron? \_\_\_\_\_

Does it go well with other materials in the room? \_\_\_\_\_

### Color and Trimming

Is the color in harmony with oth-

er room colors? \_\_\_\_\_

Did you select simple design for trimming? \_\_\_\_\_

### Your Work

Are the hems even and correctly turned? \_\_\_\_\_

Did you use a strong hemming stitch? \_\_\_\_\_

Did you close the hem ends for a short space? \_\_\_\_\_

Is embroidery neat on right and wrong sides? \_\_\_\_\_

### Appearance

Is it clean and well ironed? \_\_\_\_\_

## A Place To Store Things

Do you have space in your room for all of your possessions? This is a good time to begin to improve dresser and closet storage.

---

**Choose and make ANY TWO** items shown on pages 14 through 17.

---

Handy pockets attached to the sides of dresser drawers save space that is usually wasted. Ask your

leader for directions if you wish to make them.

### HANDY POCKETS

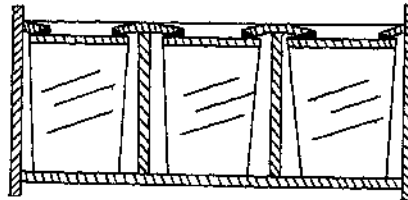

**Use handy pockets for small items in your dresser drawers.**

To keep a dresser drawer from being a "tumble-jumble" try making dividers. You will be surprised how much space you gain.

Choose heavy cardboard plain or in color,  $\frac{1}{8}$  inch plywood, or  $\frac{1}{4}$  inch balsa wood. Cut two or three pieces the length of your dresser drawer and 2- $\frac{1}{2}$  - 4 inches wide. Notch them (see drawing) by cutting slots the thickness of the board and halfway through, to permit one board to slip into another.

### DRAWER DIVIDER

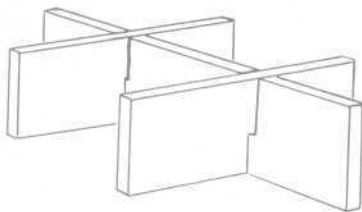

Here's a simple divider for a dresser drawer.

### EASY-TO-MAKE SHOE-SHINE STOOL

Here's what you need for this handy shoe-shine stool:

$\frac{3}{4}$  inch pine lumber: 2 ends, 6 by 7 $\frac{1}{2}$  inches  
1 top, 7 $\frac{1}{2}$  by 12 inches  
1 bottom, 3 $\frac{1}{2}$  by 9 inches  
2 sides, 6 $\frac{1}{2}$  by 9 inches

1 dowel,  $\frac{1}{4}$  inch diam. by 4 inches long

2 small hinges

### HANGERS

The simplest hangers are important storage items. Choose strong wood hangers, sand them satin-smooth and finish with one or two coats of hard varnish, shellac or enamel.

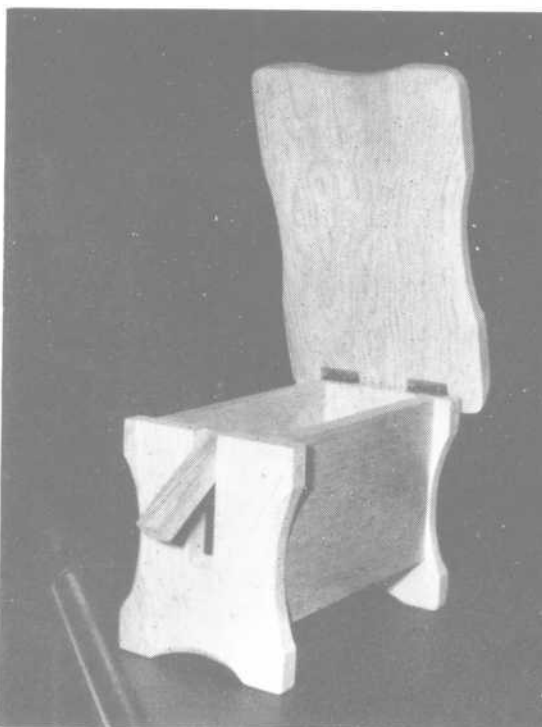



## DRAWER TRAY

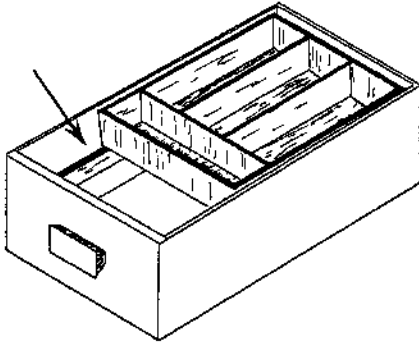

Cleats (see arrow) made of half-round ( $\frac{1}{2}$  inch) or of  $\frac{1}{2}$  inch striping, fastened by wire nails to the sides of any dresser drawer, will support a sliding tray for small articles. This leaves the bottom of the drawer free for storing larger items.

## SIMPLE SHOE RACK

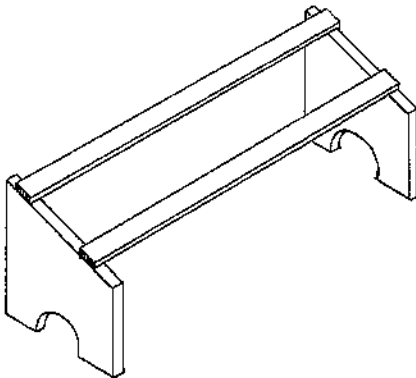

This easy rack requires no special tools.

Select these materials:

2 end pieces—8 inches long, 8 inches high at back, and 5 inches at front

2 strips lath—21 to 24 inches long

12 boxes nails

Sandpaper

Set the back lath at least 2 inches forward from the tip of the end piece to clear the closet wall. Space between the laths depends on length of shoe.

## ON-THE-DOOR SHOE RACK

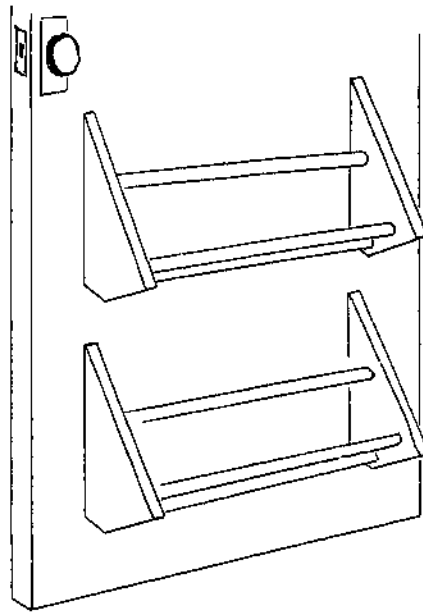

Here's an easy type of shoe rack for you to make. Plan on as many units as you need for all your shoes. This rack screws to the back of a door. One rack holds 2 or 3 pairs of shoes. You will need these materials for each unit:

1—1x6 board 16 inches long, for two ends  $5\frac{1}{2}$  ft. of  $\frac{3}{8}$  inch hardwood dowels for cross rods (will cut 3 rods)

6— 4-penny finishing nails

2—  $1\frac{1}{4}$  inch #8 flathead wood screws

Sandpaper

Length of cross-rods depends upon the width of the door. Allow  $2\frac{1}{2}$  to 3 inches clearances at ends for door to swing. Mount rods in drilled holes. Glue with resin glue.

## PEGBOARD

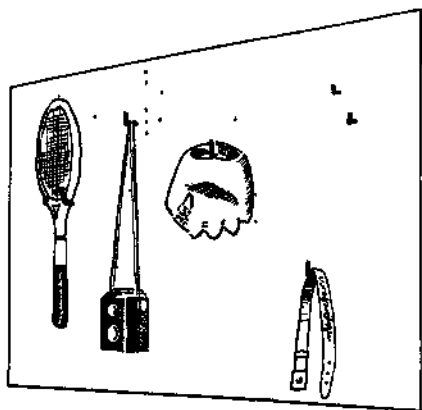

Peg boards provide extra storage space.

## HAMPER

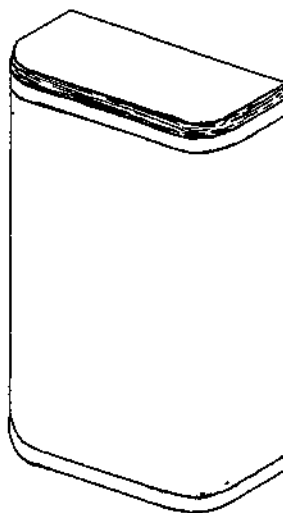

A clothes hamper helps make your room neat.

## SHOERACK

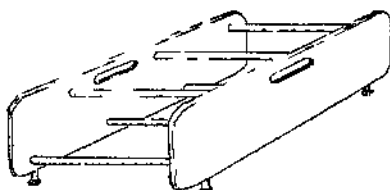

Here are the materials needed for the closet-floor shoe rack. It is just one of many kinds.

2 ends—5- $\frac{5}{8}$  inches wide and 18 to 24 inches long, made of 1 x 6 board or  $\frac{3}{8}$  inch ply.

6 crossrods— $\frac{1}{2}$  inch dowel, 21 inches long (varies with closet wall space). Set at 7-inch intervals.

1 dowel ( $\frac{1}{2}$  inch, 15 inches long). Cut into 4 pieces for legs, each 3- $\frac{3}{4}$  inches tall).

12 4-penny nails  
Sandpaper

Glue dowels into drilled holes, using resin glue. Add these features if you wish: hand slots; rubber cane-tips on legs of rack.

## LAMP-BULB SHELF

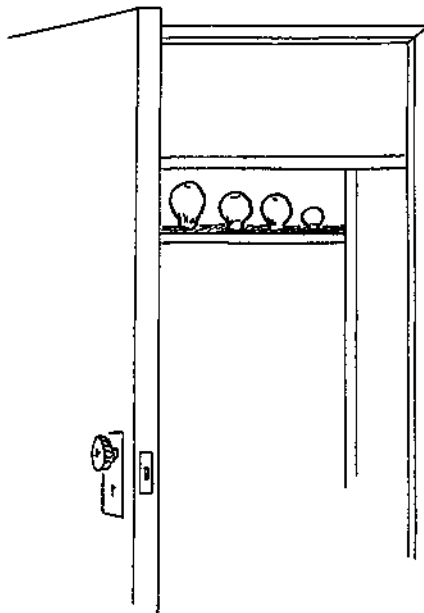

Store lamp bulbs on an easy-to-reach shelf. They fit snugly into holes drilled for each by using a brace and bit.

## Woods Need Finishing

Storage items made of wood need finishing. Let's learn the four simple first steps in wood finishing. Later, in other room improvement projects, you can master more difficult finishes.

1. Make a sanding block.
2. Sand wood correctly.
3. Learn to use paint, enamel, or varnish.
4. Care for your brushes.

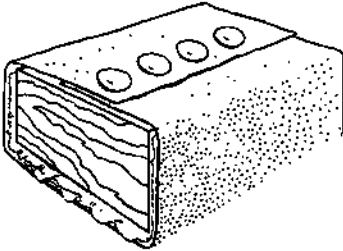

### *Sanding Block*

A good sanding block makes your work easier.

No wood can look finished unless it is well sanded. This takes time and much "elbow grease." Use plenty of both to make the wood "satin-smooth!" Get all sawdust off because it makes bubbles under the finish. Wipe, brush, or dust the piece—but get dust off!

### **Put On The Finish**

Use a "one-coater" finish. Nowadays you can buy excellent varnish, paint, or enamel that require only one coat. Choose colors to harmonize with your room and make your storage item one to be proud of.

Varnish and enamel will be much prettier if "rubbed down" with oil. Ask your leader about this.



Clean your paint brush well when you have finished the job.

### **Take Care Of Your Brushes**

A good workman cleans his tools, so do not neglect your brushes. Clean them as soon as you finish a paint job.

Clean with a thinner required for the coat used or a general purpose thinner sold at paint shops. Use turpentine or solvent to clean paint, ordinary enamel, and varnish brushes. A shellac brush needs wood alcohol as a cleaner.

Finally, wash your brushes in warm sudsy water, rinse and press out extra water and dry carefully. Cover the bristles with clean oiled paper or foil and store flat.

### **Play Safe**

Be careful when you use paints, turpentine, or solvent. All are flammable. Destroy rags and papers used while finishing woods.

# Pictures Will Help Your Room

## Suitable Pictures

What pictures are suitable for a club member's room? The subject depends upon your age and your hobbies or interests. For example, if you grow flowers, then flower pictures could be your choice. If you love horses, dogs, birds, etc., you may choose these. Arizona desert scenes make nice pictures, too.

Check the colors in a picture. If they are in harmony with color already in your room they will add to the good effect.

Study the frame when buying a picture. Is it so fancy that it draws attention away from the

story the picture has to tell? Simple frames are always in good taste.

You are not required to make a picture but if you have a print you like, you could bind it with tape, or put it in a frame that you have chosen.

A taped picture takes patience in handling the print, the glass, and the tape. You will find directions for making it in the section of "Extras" on page 24.

## Pictures Will Dress Up Your Room

A picture can make your room more attractive if you choose it carefully.

# How Is The Light In Your Room?

Eyes have three enemies. These enemies are:

- Glare.
- Not enough light.
- Shadows.

Incorrect lighting damages your eyes. Learn which bulbs will give desirable light.

The bulbs have names such as "Inside Frosted," "New White," "Silver Bowl," "Pink," and a very good one called "G-40." The G-40 bulbs will interest you because they are made to hang in a cluster from the ceiling.

The New White, Silver Bowl, and G-40 are very kind to your eyes. But even the kindest bulb

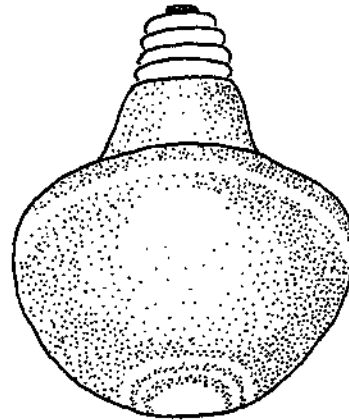

This is the new G-40 light bulb. It is yellow inside and has three rings of clear glass as shown in the drawing.

must be strong enough to help you see well. The strength of the bulb is measured in "watts." They are marked plainly on each bulb, so learn the watts needed in different places in your room. And learn to read watts on bulbs.

- Ceiling lights need 60 to 100 watts.
- A study lamp needs NOT LESS THAN 75 to 100 watts.

- A dresser lamp needs 100 watts.

Do your lights pass the test? Report about them on page 27.

Don't forget that bulbs work best in certain positions. Silver bowl bulbs always "hang down." So do G-40's. But the New White can work upright or hanging.

## Make Your Room Shine

You made articles to dress up your room and to add storage, but every room needs to shine. Care will keep it neat. Learn to be a good housekeeper in this project.

### Every Day

- Hang up your night clothes and extra day clothes.
- Put odds and ends away.
- Straighten your dresser top.
- Put soiled clothes in clothes bag or hamper.
- Air your bed and make it.

### Once Each Week

- Strip the bed; change sheets and cases and remake it.
- Dust furniture and sweep or dust-mop floor.
- Empty the waste basket.

### Be A Skillful Bedmaker

As a beginner you need first to learn how to miter or "square" the

corners of bedding and to make a smooth bed. Later you can learn to save steps in bedmaking.

There are sheets made with corners squared. They are called "fitted" sheets. If such sheets are used in your home, learn to make the mitered corner on the blankets on your bed.

Here's how to make mitered corners.

**Step 1.** Stack folded bedding on chair near bed. (Put bedspread on the bottom; then blankets, sheets, and cases).

**Step 2.** Put mattress pad in place.

**Step 3.** Put bottom sheet on bed, right side up, with wide hem toward the head of the bed.

**Step 4.** Tuck sheet in at the head and foot of the bed. Miter or "box" the corners. Tuck the sides in, very tightly. (See drawing).

**Step 5.** Put the top sheet on the bed wrong side out. In this way the right side folds over the cover at the top. The amount you fold over depends on the length of the

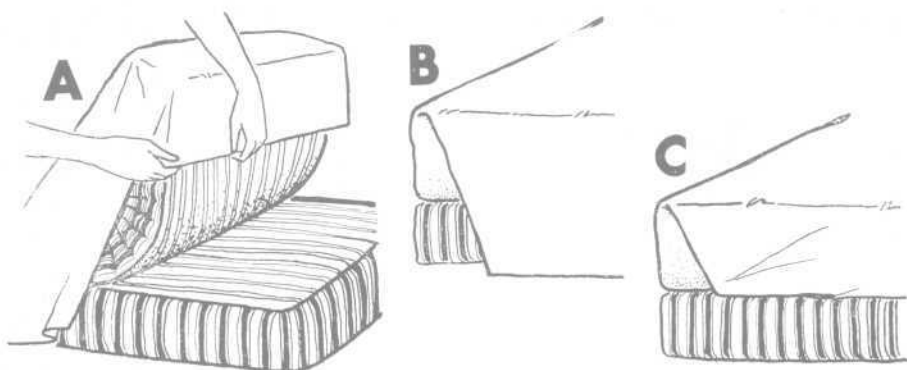

These are the three steps in turning good mitered corners for sheets or blankets. "A" Tuck end under mattress. "B" Fold into half-triangle at the side. "C" Tuck triangle end under mattress along the side.

sheet. It is often four to eight inches.

**Step 6.** Tuck in at foot. Miter the corners.

**Step 7.** Put extra cover on. Tuck in at the foot and miter the corners as you did with the sheets.

**Step 8.** Fold the extra length of the top sheet over the cover.

**Step 9.** Put spread on. Allow enough length at the head of the bed to cover the pillows.

**Step 10.** Plump the pillows and make a bolster roll if you wish or leave pillows flat.



Use a simple, sanitary method of putting a pillow slip on the pillow. "Break" the pillow lengthwise by creasing with your arm. Hold two ends tightly as shown in the picture and slip the creased pillow into the case. Push the corners neatly into shape. This is only one of the easier methods.

## Handy Cleaning Tools

You will need handy cleaning tools to make your work easier. A dusting mitten is a very good example. Use it to keep things spic and span and to protect your hands. The mitten can gather and hold dust on its soft, fluffy surface. Store it safely in a covered jar or can.

### Making Dusting Mitten

Ask your mother for a piece of a Turkish towel large enough to cut a strip  $14\frac{1}{2}$  inches long and 9 inches wide. Fold it crosswise into a piece  $7\frac{1}{4}$  inches by 9 inches. Pin the raw edges. Shape the top in a circle across your fingers to fit the oval of your hand. Allow enough room inside to move your fingers as you dust.

Baste the edges. **Turkish toweling is too heavy to stitch on the machine without basting.** Stitch on the machine  $\frac{1}{2}$  inch from the edge on the rounded side. Leave the wrist open. If you keep in mind that this is a "housekeeping" mitten you will know why it does not need fine finishing at the wrist. Stitching needs to be strong and straight enough to last through several washings.

Spread the side seams open, then turn the unhemmed wrist-edge  $\frac{3}{8}$  inch to the wrong side in a **single** turn. Baste. Stitch one row of stitching  $\frac{1}{8}$  inch from the ragged edge and a second row  $\frac{1}{8}$  inch from the turned edge.

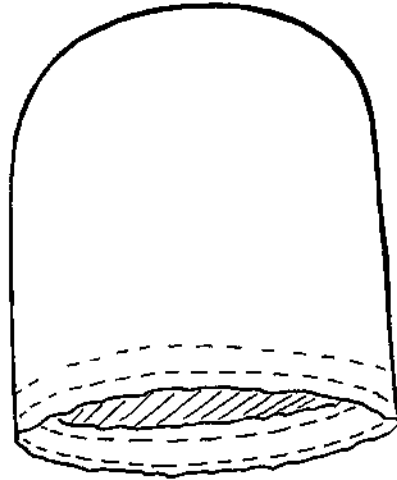

**Turn a raw-edged hem at the wrist and stitch twice.**

You may slash the outside curve of the seam if you choose, but do not make **deep** cuts. A small "snip" halfway through the seam opposite each finger tip is all you need. The picture below shows how to slash the edge.

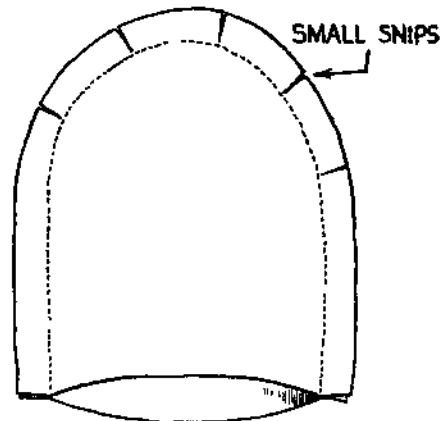
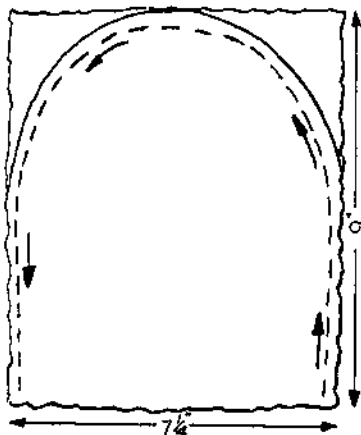

**Make small snips to ease the curve over your fingers.**

## Use Good Floor Tools

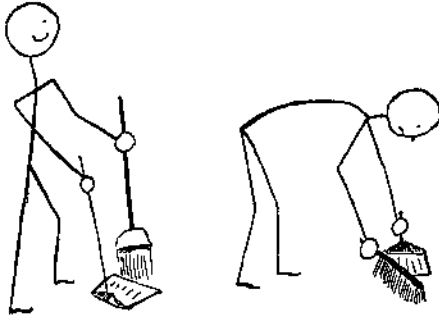

Do you work like this? Or this?

If possible use long-handled mops, brooms, and dustpans to save energy and help your posture.

## Are Your Clothes Helter-Skelter?

All your clothes deserve care. Follow the suggestions for clothing care which you learned in other 4-H projects. Your new storage articles will help you keep your clothing and accessories in good condition.

## “Extras” For Your Room

On page 2 there are some suggestions for “extras” if you choose to make them. You will need no special directions for making additional storage articles from the suggestions.

However, if you choose to tape a favorite picture as an extra, follow the steps given on page 24, and work accurately.

You will need these supplies:

- Roll of gummed tape. (You may use cloth tape, passepartout, mystik, or other cloth tape in color or black or white).
- Glass the size of your picture.
- Two cardboards (about  $\frac{1}{8}$  inch thick) the size of the picture to be framed.
- Paste, glue, or photographer's paste.
- Scissors, pencil, ruler, and two clip clothes pins.
- Hangers suitable in size to support the picture.

## Mats For Pictures

Perhaps you should think carefully about whether to put a mat around your picture. People do not agree about which pictures need mats. For this reason, here are facts about sizes and shape of mats. You and your leader will have to decide two things before you begin to tape a picture.

1. Would a mat improve your picture?
2. Do YOU have the SKILL to cut a mat neatly and accurately? An untidy mat is worse than none!

Some pictures are improved by the use of mats. A mat is cardboard or heavy paper cut to make margins around a printed picture. Also, a mat keeps the glass from rubbing the print. Oil paintings are not matted.

You may cut out the mat to frame the picture, or you may paste the print onto the mat, leaving margins. Attach only the two top corners.

Ask your leader to help you decide the width or depth of the margins. The space depends on the size



and kind of picture, but there are rules to remember about mats:

(a) Mats of uneven margins are better in design. Leave more space at the bottom than at the top.

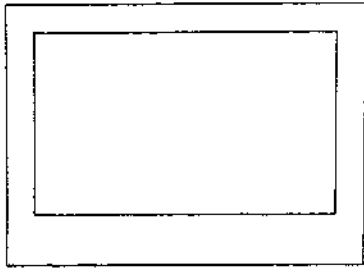

(b) Sometimes when a picture is much wider than high (a horizontal picture) the mat spaces on top and bottom are narrower, and alike, while the side spaces are wider, and alike.

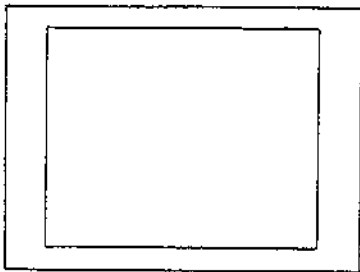

## Taped Pictures

These are the steps in making a taped picture:

**Step 1.** Trim the picture accurately. If the print has light-colored margins, it will be more interesting if you leave the bottom wider than the remaining three sides. Trim the cardboards to this same size. Use your ruler to make even lines for cutting.

**Step 2.** Attach the print to one of the cardboards by pasting only the two TOP corners. This prevents bubbles under the paper. Use very little paste.

**Step 3.** Wash and polish the glass. Cut two pieces of tape from the roll one inch longer than the sides of the glass.

**Step 4.** It is wise to tape the sides of the picture first; top and bottom later. Decide on the width of the tape desired. Large pictures (8 inches or larger) need  $\frac{1}{2}$  to  $\frac{3}{4}$  of an inch showing as the frame.

Stick the tape to one side of the glass. Smooth it on in a straight line. Later you will use the free edge to fasten the back cardboard to the glass. See diagram below. Fasten the tape on the opposite side.

**Step 5.** Place the glass face down on the table, then place the

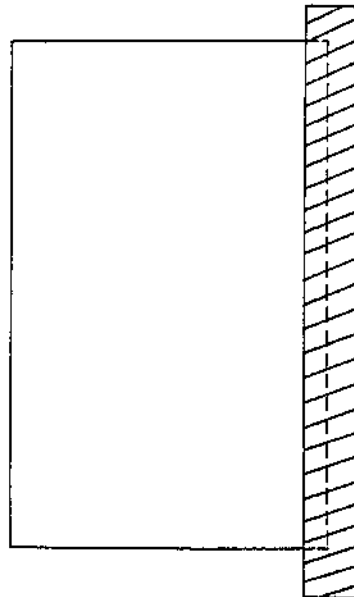

**Stick the tape to one side of the glass.**

picture face down on the glass. Cover with the cardboard back. Hold these pieces together with clip clothes pins, to give you a chance to examine the picture for evenness and margins.

**Step 6.** Fold the loose edge of one tape over the glass and cardboard and stick it tightly onto the board. Check to see if all parts are straight. Then attach the other tape. Trim even with the glass.

**Step 7.** You are now ready to put the end tapes in place. Cut the two end tapes one inch longer than the glass. Stick one tape edge across each end as you did with the side tapes.

**Step 8.** Cut the corners at an angle, called a miter (see drawing), or make them square. A mitered corner is more difficult, so be sure to choose the kind of corner you can do neatly. NOTICE that only the FRONT of the miter is cut. This leaves a strong straight piece to fold to the back and stick in place. You can fold the back of the square corner in the same way.

**Step 9.** Attach the hangers. Hangers balance the picture, so place them below the top and in the upper third portion of the picture.

Polish the glass and your picture is ready to hang or to go to the Fair!

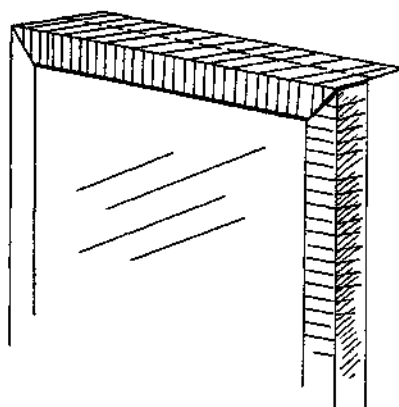

Cut corners at an angle.

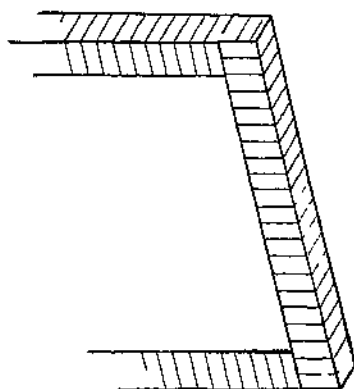

A strong straight piece of tape is left to fold to the back and stick in place.

---

COVER PICTURE shows Bonnie Brooks and Cleve Seal of the Wrightstown 4-H Club in Pima county.

Acknowledgment: Planning Your Room -Hartel-C 721; Iowa Agricultural Extension Service.



## Room Improvement Record No. 3

Name \_\_\_\_\_ Address \_\_\_\_\_

County \_\_\_\_\_ Club Name \_\_\_\_\_ Age \_\_\_\_\_

### WHAT I LEARNED TO MAKE, BUY, OR SELECT

	Items Made	Supplies Bought	Articles Bought or Selected
<b>Hemmed Article</b> (check here <input type="checkbox"/> )			
<b>Towel</b> _____ hand			
_____ guest			
_____ finger-tip			
<b>Scarf</b> _____ for dresser			
_____ for chest			
<b>Storage</b> (name the item)			
For dresser _____			
For closet or clothes _____			
For wall _____			
<b>Wood Finish</b>			
Sanding block _____			
<b>Light Bulbs</b>			
Kind _____ Watts _____			
_____			
_____			
_____			
<b>Cleaning</b>			
Dusting mitten _____			
<b>"Extras" for self or family</b>			
What article? _____			

## MY ACTIVITY RECORD

Gave Demonstrations (check where ✓) Club \_\_\_\_\_

County Event \_\_\_\_\_

Exhibited Work

Achievement Day \_\_\_\_\_

4-H or County Fair \_\_\_\_\_

State Fair \_\_\_\_\_

Helped My Club As An Officer

\_\_\_\_\_  
Name Office

Attended \_\_\_\_\_ Meetings

