

EXPERIMENTAL EVALUATION OF MSK AND OFFSET KEYED QPSK THROUGH SATELLITE CHANNELS

D.F. Horwood, P.S. Angello
Hughes Aircraft Company, Space and Communications Group
El Segundo, California U.S.A.

ABSTRACT

Laboratory test measurements show nearly equivalent error rate performance of MSK and OKQPSK modulation formats for channels having bandwidths approximately equal to the bit rate bandwidth and typical associated phase delay characteristics. High quality MSK and OKQPSK transmitters and a versatile modular receiver have been designed and constructed to eliminate differences associated with varying degrees of hardware quality when the performance of the various modulation formats is compared. The selection of a modulation format should, therefore, be strongly directed by considerations other than error rate, such as complexity, sensitivity to alignment, and compatibility with differential coding.

INTRODUCTION

In recent years MSK has become an increasingly popular modulation technique for signaling through band limited channels in which data must be efficiently packed into the restricted bandwidth.^{1, 2, 3} MSK appears attractive for such signaling because more of its energy is concentrated toward the band center, and less in sidelobes, when compared to the other most popular digital modulation techniques, QPSK and offset keyed QPSK (OKQPSK).³ Each of these three signaling techniques is equivalent to a bi-orthogonal set; therefore, they perform identically in a non-band limited channel. The objective of this study is to compare the performance of MSK and OKQPSK when operating through various degrees of channel bandlimiting. Data were collected with a laboratory test modem with a 1.5 GHz carrier operating at 80 Mbps, and include both integrate and dump and passive data filters. The results indicate that for severely band limited channels offset QPSK outperforms MSK, while with more moderate band limiting MSK is better. The results also indicate that incorporation of high quality phase equalizers yields better performance improvement with MSK than with OKQPSK.

LABORATORY MODEM

A high quality, flexible 80 Mbps laboratory modem capable of operating in either MSK or OKQPSK modes with a 1.5 GHz carrier was developed. The 80 Mbps rate was selected because it is both low enough to allow accurate simulation of distortion, and high enough to evaluate performance at low error rates. To ensure modulation format differences are not masked by hardware implementation, extensive effort was given to the construction of nearly ideal performing transmitters and receivers.

Figure 1 is the block diagram of the 80 Mbps evaluation modem. This modem includes MSK and OKQPSK transmitters, which were switched into the modem as required, and a versatile modular receiver capable of demodulating MSK with sinusoidal weighting, MSK with no weighting, and OKQPSK. A matched filter receiver is one in which a received signal is correlated with its stored replica followed by an integration operation.⁴ For an undistorted MSK signal, the required operation is correlation of the received signal with the recovered carrier and a sinusoid at half the symbol rate. Such a matched filter configuration for MSK is referred to as MSK with sinusoidal weighting. When the MSK signal is correlated with only the recovered carrier, this receiver is referred to as MSK with no weighting. Demodulation of an OKQPSK signal requires correlation with only the recovered carrier. The digital test modem was implemented so that its configuration could be altered from matched MSK (sinusoidal weighted correlation) to matched OKQPSK, or to unmatched MSK (no weighting) by passive component adjustments only. This makes possible the use of the same receiver components and guarantees identical receiver characteristics for each demodulation scheme considered. The modem was assembled in the following configurations for the study.

<u>Transmit</u>	<u>Receive</u>
MSK	Sinusoidal weighting, integrate and dump data filter
MSK	Sinusoidal weighting, 2 pole data filter
MSK	No weighting, integrate and dump
MSK	No weighting, 2 pole data filter
OKQPSK	No weighting, integrate and dump
OKQPSK	No weighting, 2 pole data filter

For each of the configurations various channel filters, were located between the transmitter and the receiver. For this study, the carriers and clock were hardlined from the transmitter to the receiver.

TRANSMITTER

Figure 2 shows the photographs of the actual transmitter hardware, as well as photographs of the power spectra for the MSK and OKQPSK transmitters. For the case of an ideal MSK transmitter power spectrum, the peaks of the side lobes diminish at a rate proportional to $1/f^2$ (f = frequency) with the first nulls occurring at a frequency equal to $1.5 \times$ link data rate centered about the carrier frequency.^{2,5} The peak amplitude of the first side lobes is 23 dB down from the peak of the main lobe. For an ideal OKQPSK transmitter power spectrum, the peaks of the side lobes diminish at a rate proportional to $1/f$ with the first nulls occurring at a frequency equal to the link data rate centered about the carrier frequency. The peak amplitude of the first side lobes is 13 dB down from the peak of the main lobe. The photographs in Figure 2 indicate that either transmitter exhibits nearly ideal performance characteristics.

RECEIVER

Figure 3 shows the block diagrams for the three receiver configurations utilized during the MSK, OKQPSK study and the photographs of their hardware implementations. The block diagrams show that the only differences among the receiver configurations are the frequencies of the carrier inputs and the choice of mixer outputs used for baseband data detection. One additional subtle difference pertains to the MSK no weighting configuration and is incorporated in the bit synchronizer; this consideration is presented later.

The mathematical expression for the output of an MSK transmitter is:

$$m(t) = x(t) \cos \omega_c t \cos \Delta\omega t + y(t) \sin \omega_c t \sin \Delta\omega t \quad (1)$$

where ω_c is the carrier frequency, $x(t)$ and $y(t)$ are the modulation signals which take on values of ± 1 , and $\Delta\omega$ is the amplitude weighting frequency.

For the 80 Mbps MSK modulator under consideration, $f_c = 1.53$ GHz and equals the arithmetic average of the MSK upper carrier $f_U = 1.55$ GHz and the lower carrier $f_L = 1.51$ GHz. The amplitude weighting frequency is one-half the difference of the two MSK carriers; therefore

$$\Delta\omega = 2\pi \times 20 \text{ MHz.}$$

The MSK with sinusoidal weighting receiver is shown in Figure 3a. The expression describing the output of the in-phase channel summer is:

$$f(t) = m(t) \left[\cos \omega_U t + \cos \omega_L t \right] \quad (2)$$

where ω_U and ω_L are $\omega_c + \Delta\omega$ and $\omega_c - \Delta\omega$, respectively.

Applying to equation 2 the trigonometric identity relating the sum of two cosines to the product of two cosines and substituting the symbols defined beforehand gives:

$$f(t) = 2 \left[x(t) \cos \omega_c t \cos \Delta\omega t + y(t) \sin \omega_c t \sin \Delta\omega t \right] \cos \omega_c t \cos \Delta\omega t \quad (3)$$

Elimination of higher frequency terms yields the expression for the signal input to the detection filter:

$$f(t) = x(t) \left[1 + \cos 2 \Delta\omega t \right] = x(t) \left[1 + \cos 2\pi(40 \times 10^6)t \right] \quad (4)$$

Equation 4 is an expression for a raised cosine data stream. Figure 4a is a photograph of the breadboard data waveform for this configuration.

The block diagram and breadboard photograph of the MSK no weighting receiver are shown in Figure 3c and 3d, respectively. This receiver is identical with the MSK sinusoidal weighting receiver with the exceptions of the substitution of one carrier input f_c for both f_U and f_L and the removal of the resistive summers preceding the data filters. (The carrier f_c is generated from the two MSK carriers f_U and f_L by specially constructed peripheral test equipment.) In addition, since the amplitude weighting function in the receiver is removed, the 180° phase inversion caused by the 20 MHz weighting function in the transmitter is restored in the bit synchronizer by modulo 2 addition of the detected data with a 20 MHz squarewave.

The mathematical expression for the signal preceding the data filter for the in-phase channel is:

$$f(t) = m(t) \cos \omega_c t = 2 \left[x(t) \cos \omega_c t \cos \Delta\omega t + y(t) \sin \omega_c t \sin \Delta\omega t \right] \cos \omega_c t \quad (5)$$

This expression reduces to:

$$f(t) = x(t) \cos \Delta\omega t = x(t) \cos 2\pi(20 \times 10^6)t \quad (6)$$

Thus, the input to the data filter is a half sine data stream. The waveform represented by equation 6 is modulo 2 added to the 20 MHz squarewave to produce valid data. Figure 4b is a photograph of the breadboard data waveform for this configuration.

Consider an OKQPSK signal as a third input to the receiver shown in Figure 3c. This receiver is identical with the MSK no weighting receiver with the exception that no phase correction is performed in the bit synchronizer.

The mathematical expression for the output of an OKQPSK transmitter is:

$$m(t) = x(t) \cos \omega_c t + y(t) \sin \omega_c t \quad (7)$$

The input to the detection filter for the in-phase channel is expressed as:

$$f(t) = m(t) \cos \omega_c t = \left[x(t) \cos \omega_c t + y(t) \sin \omega_c t \right] \cos \omega_c t$$

which is the required processing for OKQPSK demodulation.

This section has demonstrated the means by which the flexible modem receiver configuration permits evaluation of several modulation and demodulation formats without introducing experimental errors caused by hardware discrepancies.

CHANNEL FILTERS

For each of the configurations various channel filters were located between the transmitter and receiver. The filters were 7 pole Tchebyshev designs, differing only in bandwidth. The filter bandwidths were 40, 56, 80 and 113 MHz, simulating communication channels with data rate to single-sided (IF) bandwidth ratios of 2, 1.4, 1, and .7. An additional 56 MHz self-equalized filter was also constructed, having an amplitude response very similar to that of the Tchebyshev, but with much less group delay variation. This filter was used to determine the effects of improved phase equalization on system performance. Figure 5a is a plot showing the amplitude and group delay characteristics of the 56 MHz Tchebyshev channel filter. This response is typical of all the Tchebyshev channel filters. Amplitude and group delay plots of the 56 MHz self-equalized filter are shown in Figure 5b. Figure 5c is a photograph of the four channel filters and the 56 MHz self-equalized filter.

DISCUSSION OF RESULTS

For each of the three receiver configurations, bit error rate was measured with the Tchebyshev channel filters and with various receiver detection filters. Figure 6 shows a set of curves which are representative of the bit error rate data. The degradation from theory in terms of E_b/N_o at an error rate of 10^{-5} was determined from the measured data and is

summarized in Table 1. The bandwidths listed in this table are the 3dB single-sided bandwidths of the low pass detection filters and of the bandpass IF filters.

From these data the effects of the channel filters, as well as those of the receiver detection filter type and bandwidth can be determined. The data of Table 1 are summarized in Figure 7, which is a plot of degradation from theory for each of the three receiver configurations. The receiver detection filter is held fixed at the type and bandwidth which generally provided best performance for that receiver configuration. The degradation is plotted as a function of the reciprocal of the IF bandwidth-symbol duration product, $1/BT$. This normalization allows the results to be scaled to any data rate. For this system, the 80 MHz filter corresponds to $1/BT = .5$.

The results show best performance for matched filter detection of MSK (sinusoidal weighting with integrate and dump detection) when sufficient bandwidth is available, but better performance for unweighted detection of MSK or operation with OKQPSK when the bandwidth is reduced. Since the nonweighted MSK receiver with low pass detection filtering is simpler to implement than the matched receiver, it should be used with MSK in any band limited application.

Generally, the performance of MSK detected without weighting and OKQPSK was about the same; as the bandwidth was narrowed the OKQPSK performance was slightly superior. However, significant bit error rate improvement for MSK detected with and without weighting was achieved when a 56 MHz self-equalized filter having the same amplitude response as that of the 56 MHz Tchebyshev filter was inserted into the test modem. For the detection filter specified in Figure 7, the data tabulated for OKQPSK in Table 1 show a .6 dB improvement, while in Table 1 data for MSK detected with and without weighting show 2.1 dB and .9 dB improvement, respectively. In fact, computer simulations⁶ run with perfectly phase-equalized filters having Tchebyshev filter amplitude responses indicate MSK performance is superior to that of OKQPSK when the bandwidth is reduced. This result is intuitively satisfying if the spectral occupancy within the channel bandwidth is considered. Figure 8 shows the MSK and OKQPSK spectra along with typical channel filter amplitude and delay responses. It is apparent that more of the MSK signal energy is contained in the channel passband, but the additional energy is located near the filter skirts; thus, the energy contained in this region is delayed. This delayed signal energy degrades rather than aids the data detection process. With a perfectly equalized channel, the receiver takes advantage of this energy, and the performance is improved.

CONCLUSIONS AND OTHER CONSIDERATIONS

MSK AND OKQPSK are shown to offer nearly equal error rate performance when operated through band-restricted channels with nominal group delay distortion. Because of this, considerations other than error rate should play a principal role in selecting between the two formats. Some appropriate considerations are cost, complexity and sensitivity to misalignment, the ability to accommodate nonsynchronized I & Q data rates, and the compatibility of the format for use with differential encoding to resolve receiver phase ambiguities. All of these considerations favor QPSK operation. A consideration which favors MSK operation is the minimization of out of band-radiated power. The results also suggest that with sophisticated channel phase equalization, MSK can provide superior performance. However, such equalization is generally difficult and costly to achieve.

REFERENCES

1. R.M. Fielding, H.L. Berger, and D.L. Lockhead, "Performance Characterization of a High Data Rate MSK and QPSK Channel," in Proc. 1977 International Conference on Communications, Vol. 1, June 1977
2. S.A. Gronemeyer and A.L. McBride, "MSK and Offset QPSK Modulation," IEEE Transactions on Communications, Vol. COM-24, No. 8, August 1976
3. H.R. Mathwich, J.F. Balcewicz, and M. Hecht, "The Effect of Tandem Bank and Amplitude Limiting on the E_b/N_0 Performance of Minimum (Frequency) Shift Keying (MSK)," IEEE Transactions on Communications, Vol. COM-22, No. 10, October 1974
4. J.M. Wozencraft and I.M. Jacobs, "Principles of Communications Engineering," John Wiley and Sons, Inc., New York, 1965
5. M.G. Pelchat, "The Autocorrelation Function and Power Spectrum of PCM/FM with Random Binary Modulating Waveforms," IEEE Trans. Space Electron. Telem., Mar 1964
6. M. Fashano, M.C. Austin, "A Flexible User Oriented Approach to Communication System Simulation," in Proc. 1978 International Telemetry Conference, November 1978.

Receiver Configuration and Detection Filters		Back to Back	113 MHz	80 MHz	Self-Equalized 56.6 MHz	56.6 MHz	40 MHz
OKQPSK	I&D	0.4	1.0	1.0	1.7	2.2	6.5
	15.5 MHz	1.6	2.2	1.9	2.5	2.3	7.3
	17.5 MHz	1.0	1.5	1.2	1.7	1.9	6.2
	19.5 MHz	0.6	1.1	0.8	1.4	1.7	6.9
	21.5 MHz	0.7	1.0	0.7	1.2	1.8	6.3
MSK No Weighting	I&D	0.5	0.5	0.6	1.0	1.9	7.5
	15.5 MHz	1.5	1.6	1.3	1.6	1.4	8.2
	17.5 MHz	0.6	0.9	0.6	1.1	1.4	8.4
	19.5 MHz	0.5	0.5	0.5	0.8	1.7	8.2
	21.5 MHz	0.3	0.3	0.5	1.1	2.2	8.2
MSK sinusoidal weighting	I&D	0.0	0.2	0.9	1.7	3.8	7.5
	21.5 MHz	0.5	0.5	1.3	2.4	4.8	8.5
	23.0 MHz	0.3	0.4	1.2	2.3	4.7	7.8
	25.0 MHz	0.2	0.4	1.2	2.3	4.5	7.4
	27.0 MHz	0.3	0.5	1.1	2.5	4.5	7.3

TABLE 1. E_b/N_0 DEGRADATION (dB) FROM THEORY AT BER = 10^{-5}

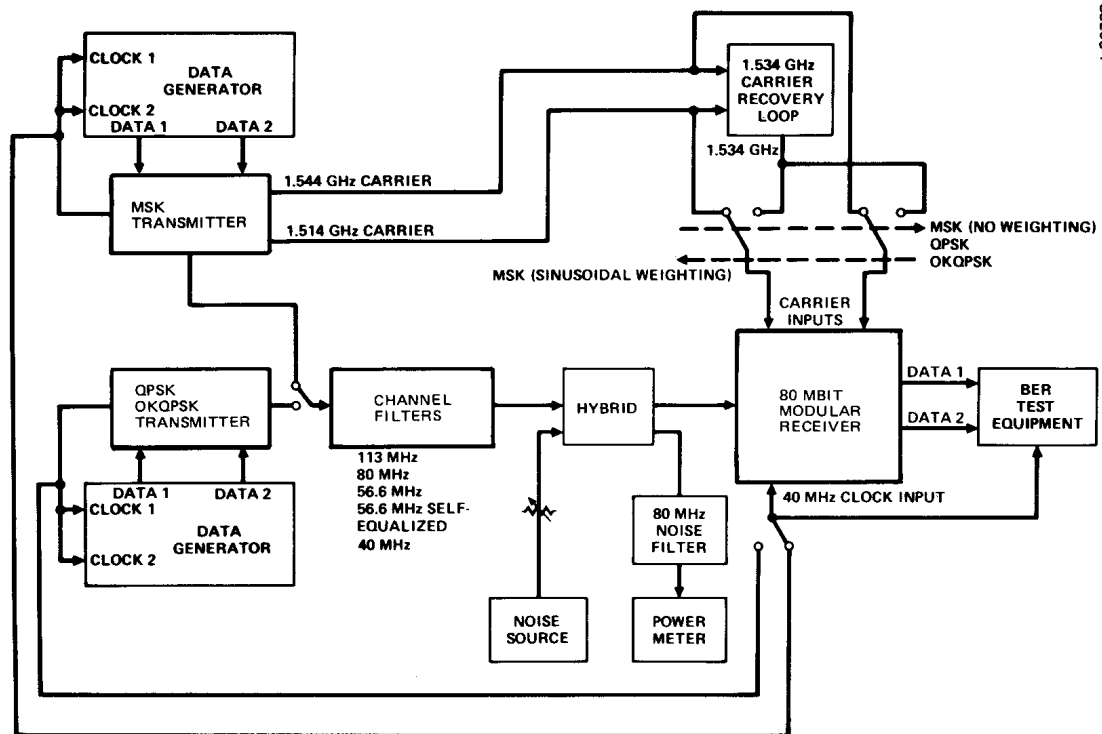

FIGURE 1. 80 MBPS TEST BED BLOCK DIAGRAM

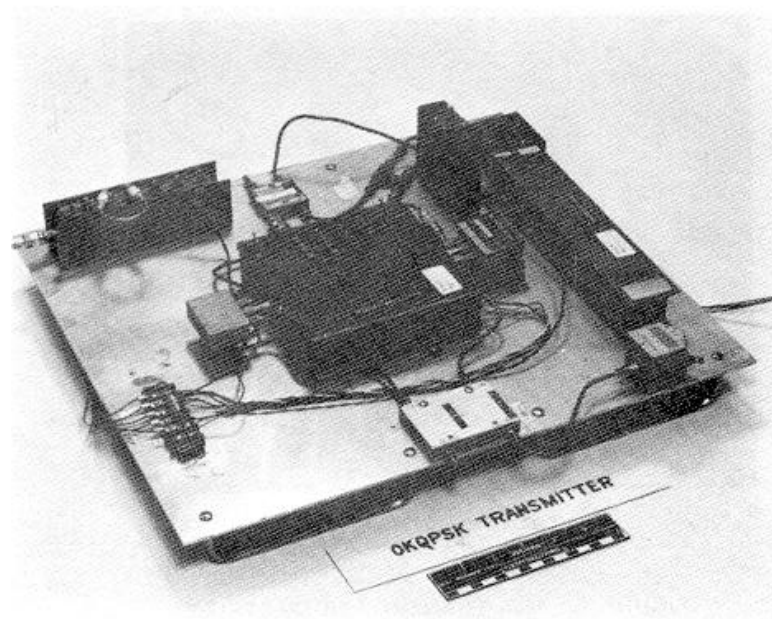

FIGURE 2A. MSK TRANSMITTER

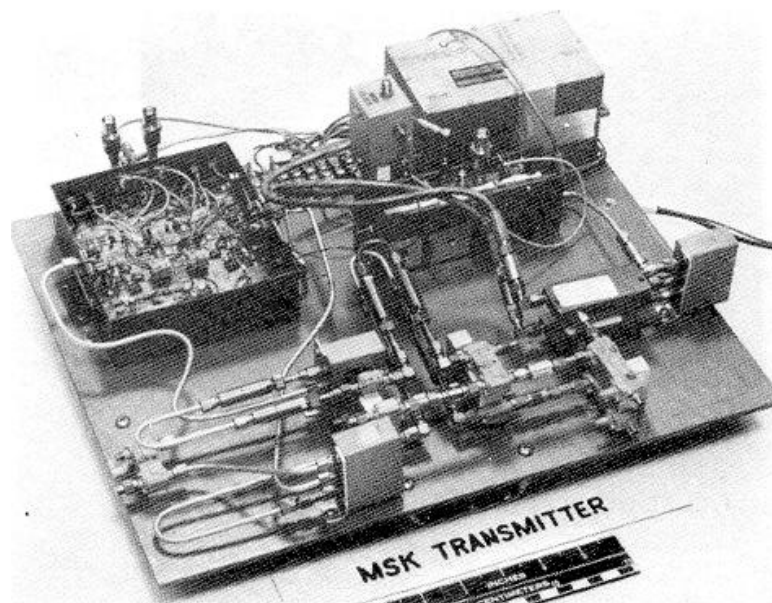
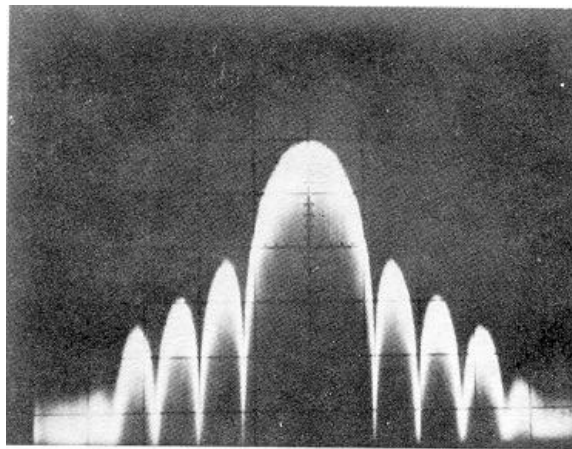
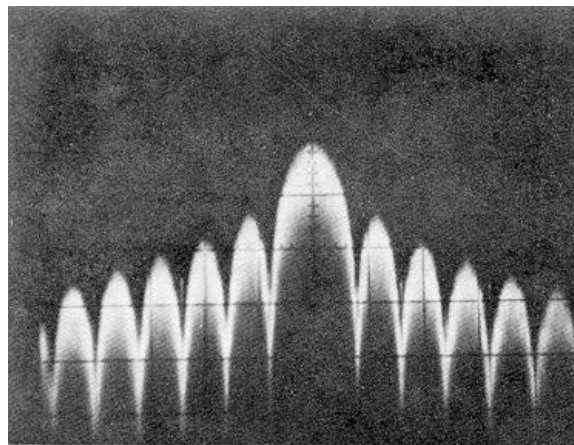

FIGURE 2B. OKQPSK TRANSMITTER



VERTICAL: 10 DB/CM
HORIZONTAL: 50 MHz/CM

FIGURE 2C. MSK TRANSMITTER SPECTRUM



VERTICAL: 10 DB/CM
HORIZONTAL: 50 MHz/CM

FIGURE 2D. OKQPSK TRANSMITTER SPECTRUM

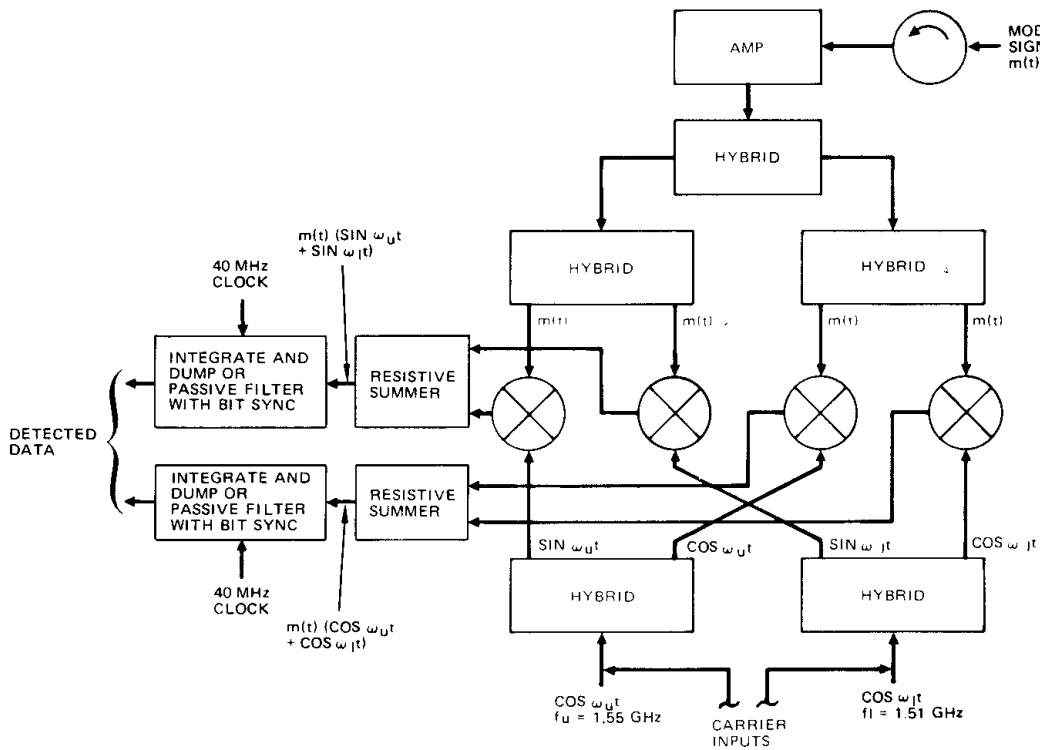

FIGURE 3A. MSK RECEIVER (SINUSOIDAL WEIGHTING) BLOCK DIAGRAM

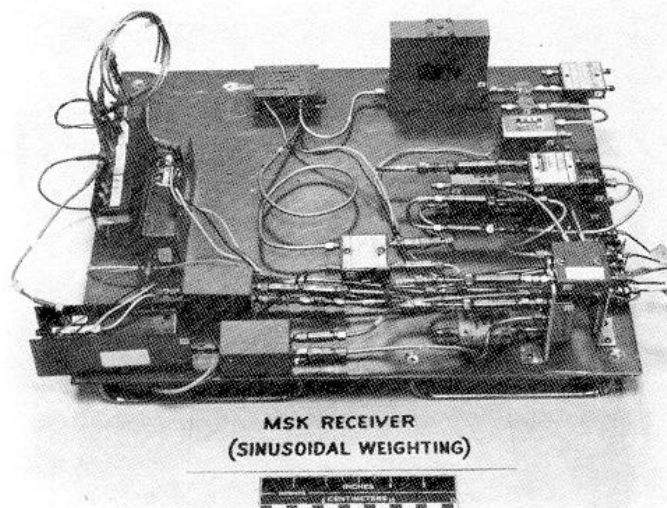

FIGURE 3B. RECEIVER CONFIGURED FROM MSK (SINUSOIDAL WEIGHTING)

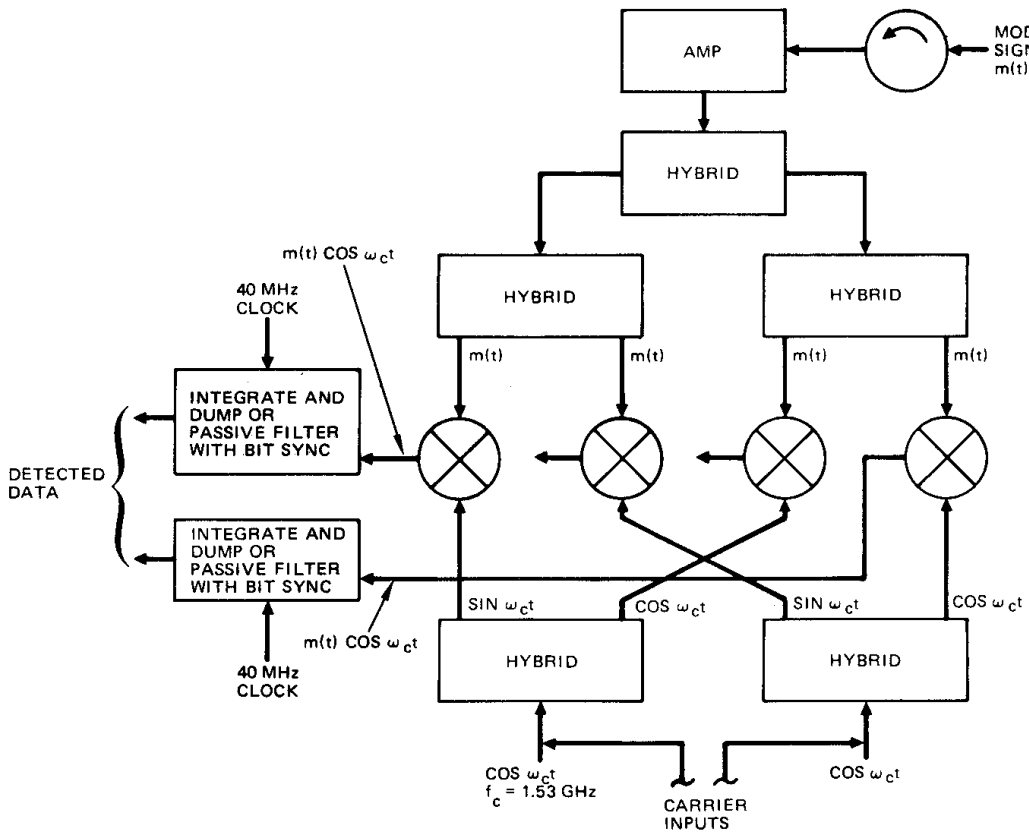

FIGURE 3C. MSK (NO WEIGHTING) OR OKQPSK RECEIVER BLOCK DIAGRAM

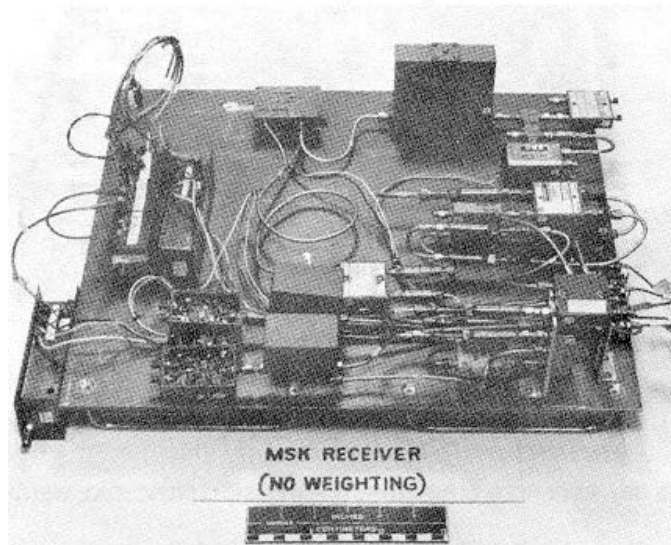

FIGURE 3D. RECEIVER CONFIGURED FOR MSK (NO WEIGHTING)

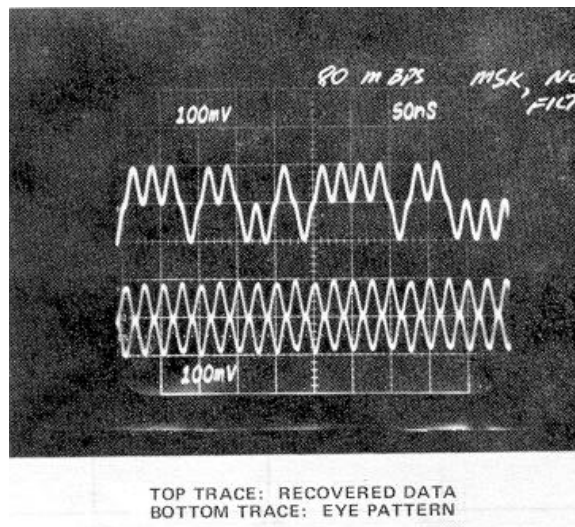

FIGURE 4A. MSK (SINUSOIDAL WEIGHTING) RECEIVER OUTPUT

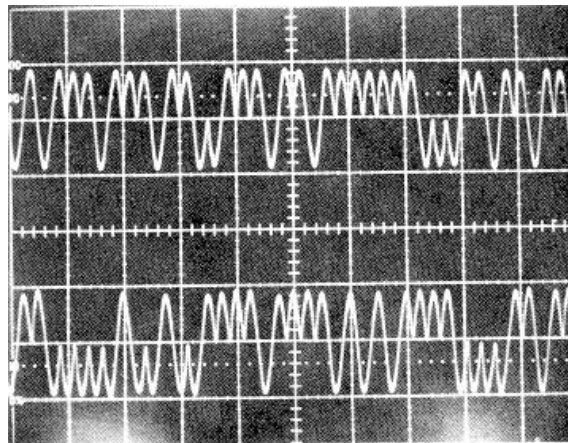

FIGURE 4B. MSK (NO WEIGHTING) RECOVERD DATA (BOTH CHANNELS)

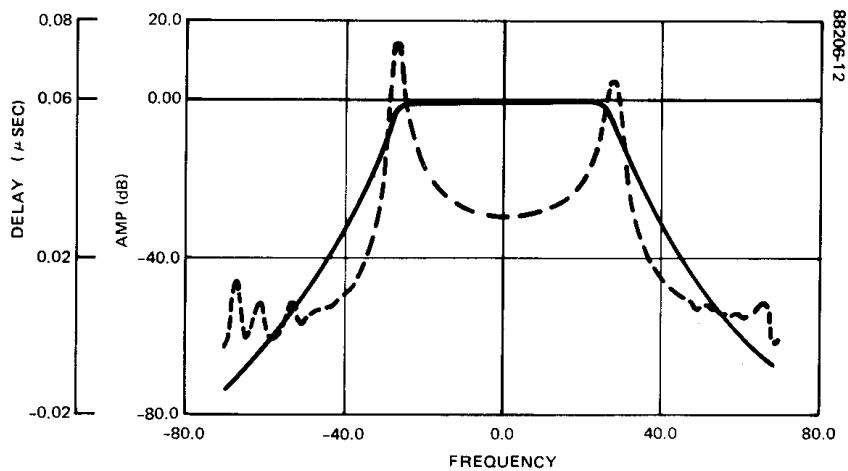

FIGURE 5A. 56 MHz TEHEBYSHEV CHANNEL FILTER RESPONSE

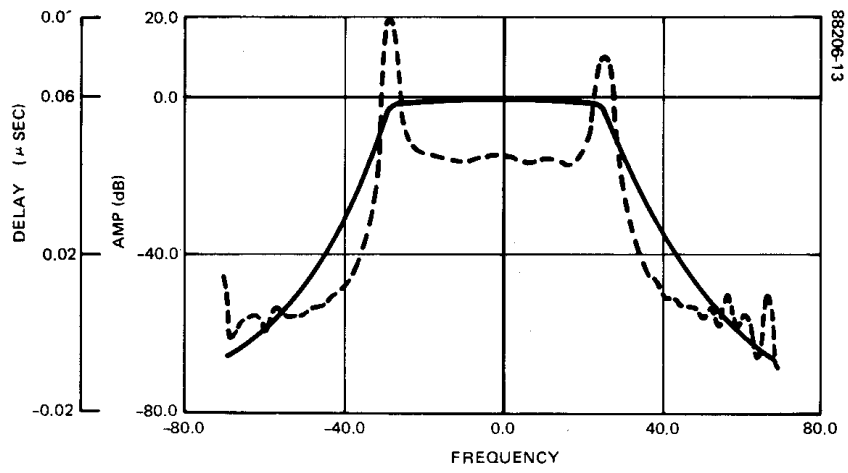

FIGURE 5B. 56 MHz SELF-EQUALIZED CHANNEL FILTER RESPONSE

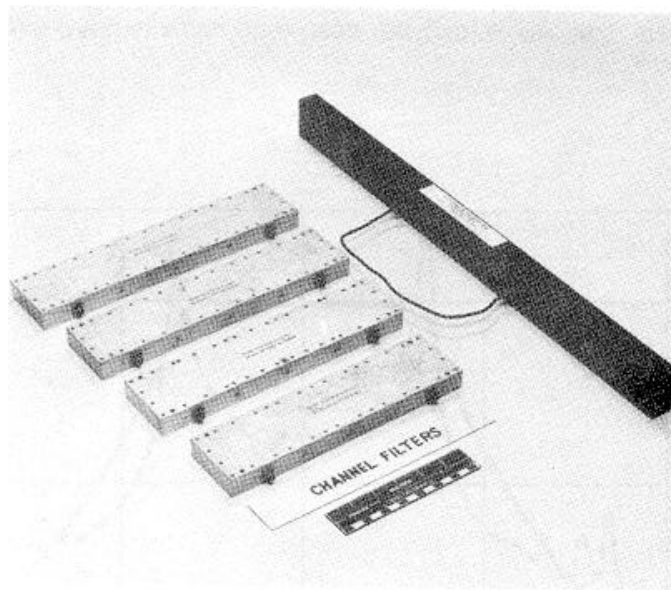

FIGURE 5C. CHANNEL FILTERS

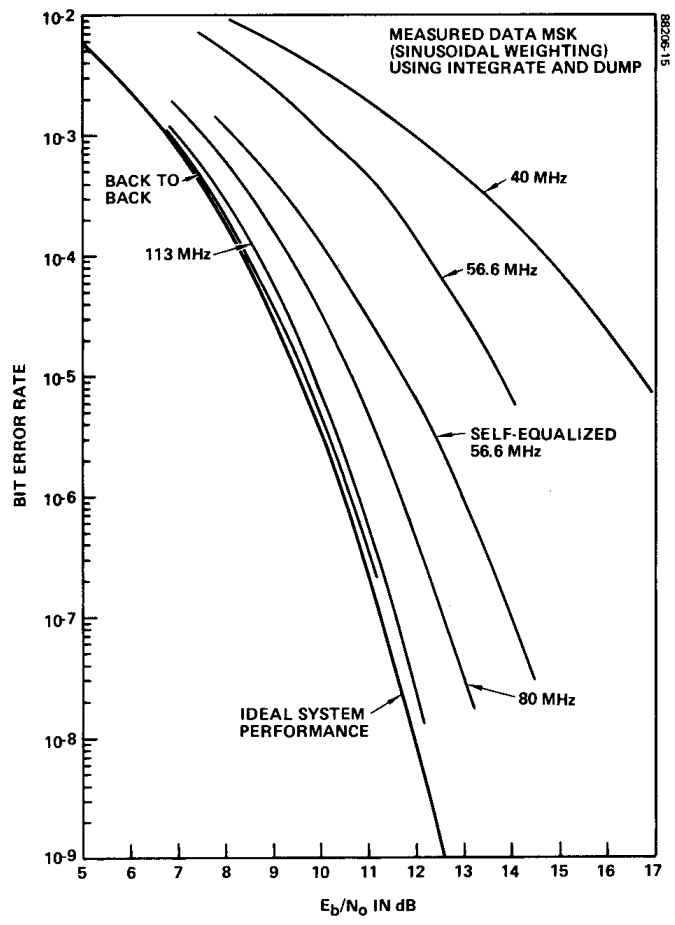

FIGURE 6. MEASURED BIT ERROR RATE DATA

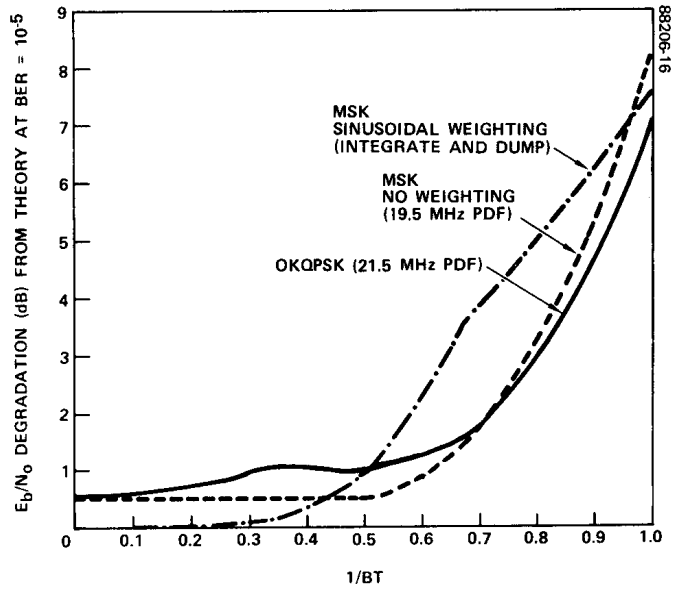

FIGURE 7. COMPARISON OF RECEIVER CONFIGURATIONS USING OPTIMUM POST DETECTION FILTERING

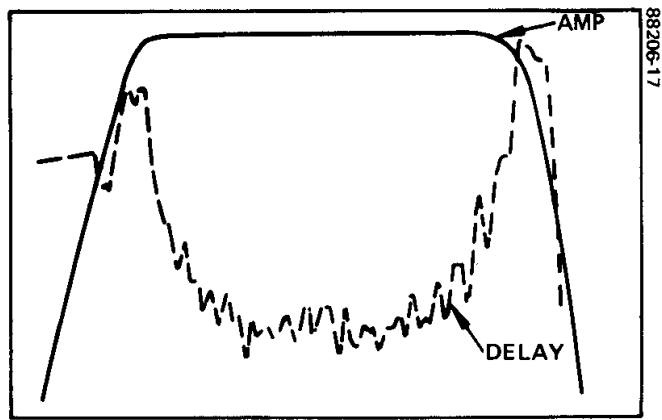

FIGURE 8A. CHANNEL AMPLITUDE AND GROUP DELAY RESPONSE

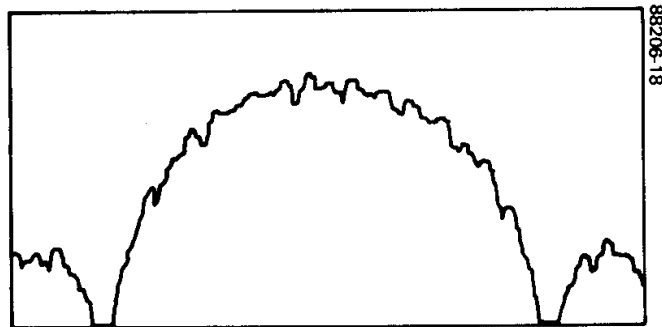

FIGURE 8B. MSK TRANSMITTED POWER SPECTRUM

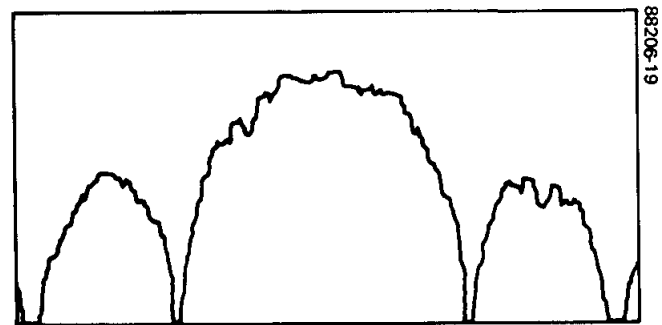

FIGURE 8C. OKOPSK TRANSMITTED POWER SPECTRUM