

BYU SAR: A LOW COST COMPACT SYNTHETIC APERTURE RADAR

David G. Long, Bryan Jarrett, David V. Arnold, Jorge Cano

ABSTRACT

Synthetic Aperture Radar (SAR) systems are typically very complex and expensive. They generate enormous quantities of data, requiring very high capacity data storage, transmission, and processing systems. We have developed an experimental SAR system with a very simple design which includes near-real-time onboard processing. This system is based on recent developments in low-cost, high-rate analog-to-digital (A/D) and digital-to-analog (D/A) data conversion systems. Most of the system is based on off-the-shelf components. A very simple RF subsystem is used. The system has been successfully operated from a moving surface vehicle and exhibits a range resolution of 2.5 m though this could be improved to 1.5 m at the expense of higher sidelobes. The four look azimuth resolution is 0.4 m. This paper describes the system as well as our plans for upgrading the system for aircraft operation and improved resolution.

KEY WORDS

synthetic aperture radar, remote sensing

1. INTRODUCTION

A Synthetic Aperture Radar (SAR) is an imaging radar which uses signal processing techniques to improve the image resolution beyond the limitation of the antenna aperture. The technology for SAR is well understood but has been expensive to implement in practical systems. In this paper we describe the design of a small, low-cost remote-sensing SAR system which provides an image resolution exceeding many existing SAR systems. Our prototype system is known as the BYU SAR [4].

The BYU SAR takes advantage of recent advances in technology to achieve high resolution in a compact system at a relatively low cost. It is designed for short range operation from a moving vehicle or a low-flying aircraft. To minimize cost and complexity for short range operation, separate transmit and receive antennas are used. A linear frequency modulation waveform (LFM chirp) is digitally generated and

transmitted. Digital to analog conversion and sampling technology are used to process the basebanded signal digitally without complicated intermediate frequency (IF) processing. This contributes greatly to reducing the cost of the system, without sacrificing system performance. The performance of the BYU SAR has been demonstrated from a moving vehicle.

2. SAR OVERVIEW

Synthetic Aperture Radar (SAR) is an imaging radar operated from a moving platform [1]. In the following we summarize a few key ideas about SAR applied to remote sensing. For a detailed discussion on the theory of synthetic aperture radar the reader is referred to [1, 2, 3]. A typical SAR imaging geometry is shown in Figure 1. Resolution in the cross-track or range direction is obtained using pulse compression and linear frequency modulation (LFM). Pulse compression reduces the transmit power requirements by trading peak power for pulse length.

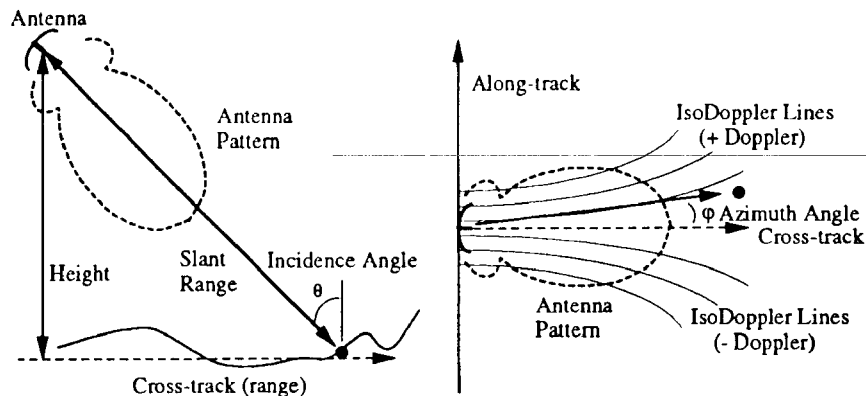

Figure 1: SAR observation geometry.

Resolution in the direction of motion or azimuth direction is achieved by Doppler filtering of the return. The Doppler frequency shift is due to the relative motion between the radar and a target. A target ahead of the radar has a positive Doppler frequency. This frequency decreases and reaches zero when the target's position vector is perpendicular to the radar's velocity vector. The Doppler frequency becomes increasingly negative as the target gets further behind the radar. The azimuth resolution of a target is achieved by matched filtering of the Doppler shift corresponding to the target. This operation is very similar to range compression and is thus termed azimuth compression. The primary difference between range and azimuth compression is that range compression is based on the transmitted chirp signal while azimuth compression is based on the Doppler shift of the target. Since the Doppler varies with range, each range bin requires a different azimuth compression chirp.

Azimuth compression is executed independent of the range compression and is usually performed after the range compression. This is because the data is gathered in streams ready for range processing, but many return waveforms are required to do the azimuth compression. Range processing can be done in real-time but azimuth compression is very difficult to do in real-time in a low-cost system. Range and azimuth compression also have different computational considerations. Both are done with fast Fourier transforms (FFTs) but while range compression can use the same transformed transmit pulse, the azimuth chirp must be recomputed for each range bin.

3. SYSTEM DESCRIPTION

A block diagram of the BYU SAR system is shown in Fig. 2. In the receiver, the return echo is mixed directly to baseband. The baseband signal is processed digitally in the computer system. The RF subsystem consists of a transmitter, receiver, and offset local oscillator generator. The transmitter mixes the 90 MHz bandwidth chirp waveform produced by the D/A system up to 10 GHz for transmission. The receiver and offset local oscillator work together in mixing the RF radar echo from the antenna to an offset baseband and the receive line amplifies it so that it can be sampled by the A/D subsystem.

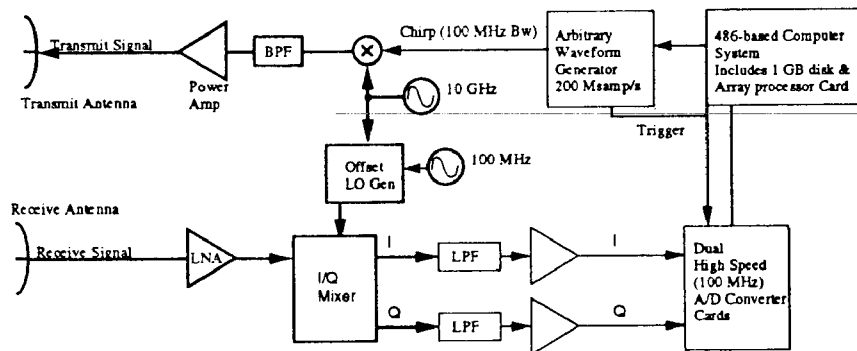

Figure 2: BYU SAR block diagram.

The transmitted signal is actually DSB modulated, i.e., the transmitted signal has both an up and a down chirp; however, only one of the sidebands is actually received and processed (see the signal frequency plan outlined in Fig. 3). While inefficient in terms of transmitted power and bandwidth, this design simplifies the generation of the transmit signal. In traditional SAR systems a single sideband signal is transmitted. However, generating a single sideband chirp requires much more expensive hardware.

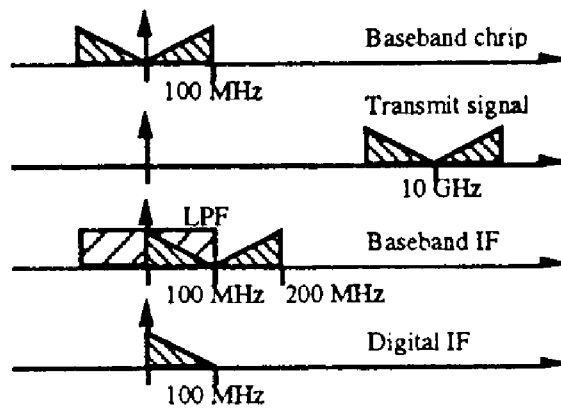

Figure 3: BYU SAR signal frequency plan.

The receiver amplifies the return echo signal by 60 dB and uses I/Q mixing to bring the signal down to baseband. The offset LO frequency is generated from the main oscillator with quadrature mixing. By carefully matching components, over 30 dB of isolation between the carrier and the IF is achieved without requiring an expensive RF filter. A 100 MHz offset is used to ensure an offset baseband signal which is then digitized. The 100 MHz offset corresponds to the bandwidth of the transmitted pulse.

3.1 Chirp Generation

The generation of the chirp signal is done with a commercial Arbitrary Waveform Generator (AWG). The AWG generates I/Q components of the chirp. The chirp is first calculated by the PC (see Fig. 4) and downloaded to the AWG's memory over an RS-232 link. A timing loop program is also transferred from the PC to the AWG. The I and Q components of the chirp waveform are then repetitively synthesized. The AWG also generates a synchronization signal for the A/D boards and is thus the central timing unit of the SAR.

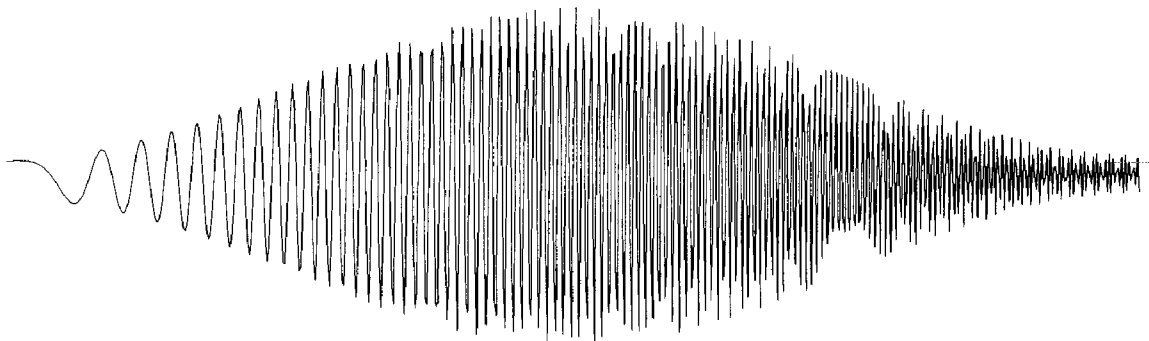

Figure 4: The transmitted signal consisting of a windowed LFM chirp.

The AWG is controlled over an RS-232 interface bus and provides the subsystem timing. The chirp data file, along with the trigger delay value, is loaded into the AWG memory over the RS-232 bus. In operating the AWG, the data file is loaded into the function generator's fast memory and the function generator is activated by commands over the interface bus. The AWG sends a trigger pulse to the sampling cards with an appropriate delay after every chirp waveform is generated. This triggers the A/D cards to begin to allow sampling the return echo. The actual transmitted waveform is a closely-spaced series of chirps at a Pulse Repetition Frequency (PRF) of 156 kHz. Most of these pulses are not received due to the time required to transfer the data from the A/D cards to the computer memory.

The LFM chirp is windowed with a Hamming window to reduce sidelobes in the range resolution. While windowing reduces the range sidelobes it also decreases the resolution.

3.2 Analog to Digital Conversion

The A/D subsystem converts the baseband continuous time waveform from the RF subsystem to a discrete time signal that can be processed by the digital computer. The two high performance boards perform this by sampling the I and Q channels at 100 MHz to provide complex 8 bit samples. The cards are slaved to provide simultaneous sampling.

The sampling cards are installed in a 486 Personal Computer (PC). A combination of custom and manufacturer's code controls the cards. When the command to acquire data comes from the PC, the boards wait for a trigger pulse from the AWG and begin sampling at the next trigger. After the desired number of samples are collected, the A/D boards are then reset for the next data collection.

The delay in processing and data transfer determines the Pulse Repetition Frequency (PRF) of the system. The PRF provides the azimuth waveform sampling. The PRF must be at least as high as the peak frequency of the azimuth chirp to allow the along-track samples to accurately represent the waveform. The peak frequency (due to Doppler shift) is sensitive to the antenna pointing direction, antenna beamwidth and the platform speed. Because the maximum Doppler is dependent on the platform speed and the fixed antenna beamwidth, ensuring that the PRF samples the azimuth chirp at the Nyquist frequency limits the speed of the radar. Alternatively, to avoid excessive oversampling, software delays must be inserted into the code to reduce the PRF.

Range compression can be done in real-time or reserved for after data collection. For real-time range compression, the time required for the range compression limits the PRF of our current system to a maximum of 31.8 Hz. This permits a top platform speed of 40 mph. While suitable for a land vehicle, this is too small for aircraft operation. Without real-time range processing the PRF can be increased to 330 Hz, allowing a maximum platform speed of 375 mph and operation from small private aircraft.

3.3 The Antenna System

Ideally, a fan-beam antenna is used on a SAR system. Typically, this is time-multiplexed between the transmitter and receiver. However, to simplify the design of the RF system, a bistatic antenna system is used with separate antennas for receive and transmit. This bistatic system allows short range imaging of relatively close targets with an arbitrarily long transmitted chirp since simultaneous transmission and reception can be done. This was done primarily to permit short range (< 1 km) operation from a moving vehicle. However, the long pulses possible with bistatic operation also improve the signal-to-noise ratio, simplify the system timing, and eliminate the need for fast RF switches.

For ground vehicle testing two X-band parabolic dish antennas have been used. These antennas are readily available from the lab but are only useful when operating the SAR from a land vehicle. Unfortunately, the narrow beamwidth of the dish antennas limited the amount of azimuth compression which could be achieved. Nevertheless, excellent images have been obtained. For aircraft operation custom microstrip antennas are being developed. To successfully implement a bistatic antenna system with the dish antennas, absorbing material was inserted between the dishes to minimize the leakage between the transmitter and receiver which can saturate the receiver.

3.4 Data Processing and Storage

In order to make images, the digitized echoes must be processed to range and azimuth compress the data. By way of illustration, Fig. 5 presents the raw digitized data. The result of range and azimuth compression of this data is Fig. 6. Both the raw and processed images have been transformed to ground-referenced grid.

Onboard processing for YSAR is structured to allow real-time implementation of range compression and display. A TMS320C30-based digital signal processing board is used to perform computationally intensive compressions (primarily 1024 point FFTs). Range and azimuth compression are both done on the DSP board. Range

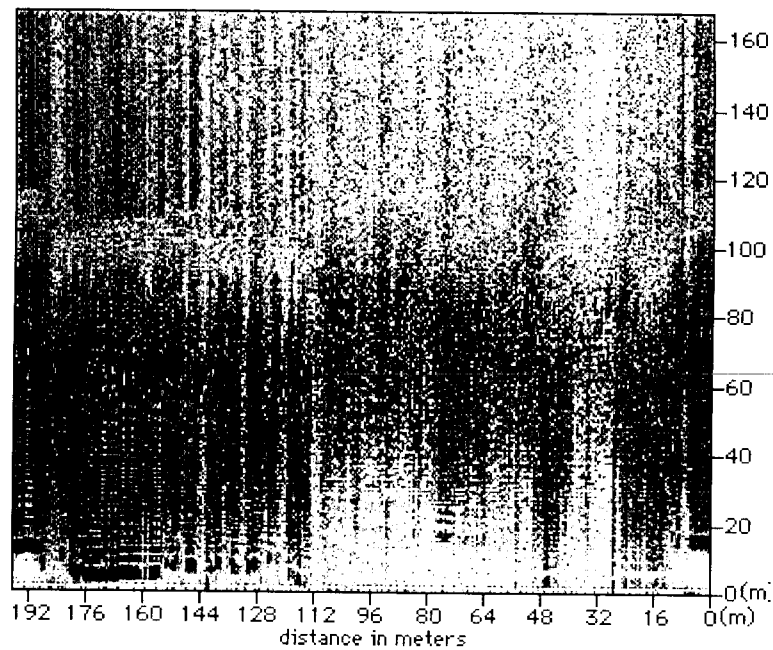

Figure 5: Raw data before processing.

processing is done first and a magnitude image of the range compressed data is displayed as the data are processed in real-time. Azimuth compression is performed on the data after a sufficient number of waveforms are range compressed.

The DSP board operates independently of the CPU and has memory that can be accessed by the CPU without stopping the board processing. This allows the CPU to control the A/D cards and transfer and store data while the DSP board does the bulk of the signal processing with the exception of the generation of the azimuth chirp which is done by the CPU.

Range-compressed data is stored in segments on a RAM drive. After 1024 range pulses have been gathered, the range-compressed data is written to disk and/or azimuth compressed. While pausing for data storage to disk results in gaps in the gathered data, it avoids the need for expensive streaming disks or tape drives. Note that the number of range pulses between disk accesses is limited only by the available RAM and can be easily increased to minimize data gaps.

Azimuth compression is also slowed by the requirement to generate a new azimuth chirp and transform it to the frequency domain for each range bin. This adds another FFT to each processing step as well as the calculations required to create the chirp. As a result the azimuth processing is generally completed in the laboratory.

3.5 System Performance

The BYU SAR is compact and light enough to be deployed from a variety of platforms, but for testing it was deployed on a small truck. We are currently upgrading the system for operation from a small plane.

While only a prototype, the system has attained high performance with an azimuth resolution better than 1 m and approximately 2.5 m range resolution. A sample process image is shown in Fig. 6 which was collected alongside a local road. The image site is a small field with a house, trees, and a diagonal fence. Key features are noted in the image. Darker foreground objects are trees. A photograph of a portion of the site is shown in Fig. 7. The line of evenly spaced dots in the foreground of the SAR image are the fence posts visible in the foreground of the photograph. The crosswire fence is difficult to see in this reproduction. At the base of the hill in the house area there is a trash can near the fence corner. The fence and trashcan are visible in the SAR image and demonstrate the azimuth resolution of the SAR. Note that (1) the SAR image is essentially a grazing angle image since the antennas are only 5 m above the field on an elevated road and (2) the antenna was depressed so that the house was not illuminated.

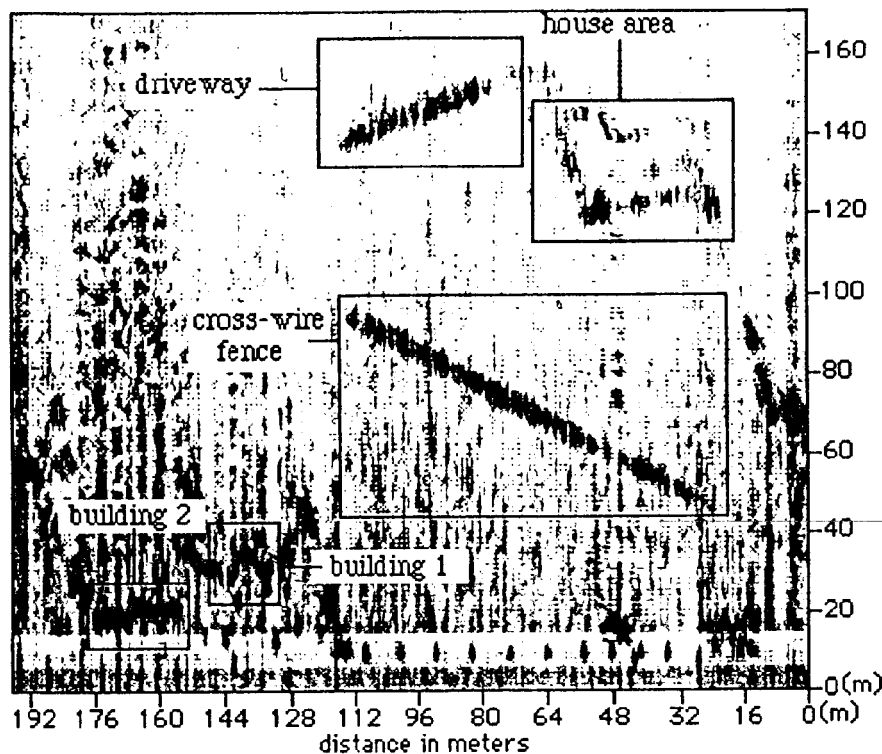

Figure 6: Processes image example indicating significant features.
Note that this is a grazing angle image.

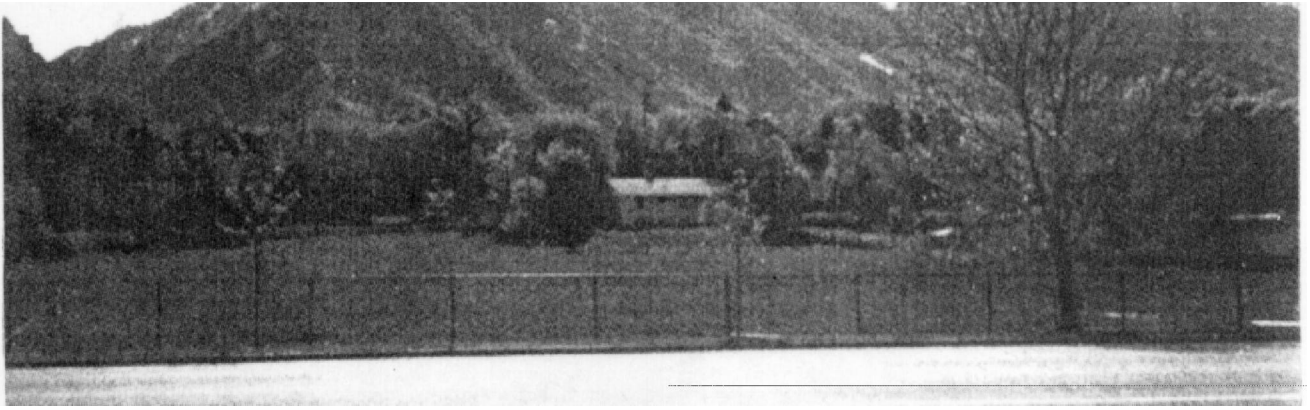

Figure 7: Photograph of portion of site. Photograph was taken from across the road at approximately the center of the SAR image with the camera aimed to the right toward the house. The other buildings in the SAR image are off to the left and are not visible in this photograph.

4. FUTURE PLANS

Currently, our system uses two 100 MHZ A/D cards, the best available when this project was initiated.

Since this time new boards have become available. As a result we are currently upgrading our system to a 200 MHZ chirp bandwidth as well as developing a custom microstrip antenna system. We are also repackaging the system in preparation for aircraft operation and hope to begin night testing in Fall 1995.

The BYU SAR system is being developed, in part, to support archeology studies. It has been previously demonstrated that SAR signals can penetrate vegetation canopies as well as dry terrain to image below the visible surface [2]. However, because of the high cost and low (10-20 m) resolution of many SAR systems, archeologists have not been able to make full use of SAR technology. The low cost and resolution of the BYU SAR may ameliorate these problems.

5. SUMMARY

Existing state-of-the-art technology and an innovative design were used to produce a low cost SAR with competitive performance. This type of a SAR system should make SAR systems more accessible to researchers. In the BYU SAR the need for an IF frequency is eliminated by an on-board processor. The use of improved technology in arbitrary waveform generation and sampling have helped to reduce the cost by performing all of the baseband processing digitally. An innovative design was employed to allow the transmission of a real waveform to save additional cost. The

range dimension resolution is 2.5 meters with very good sidelobe suppression. The azimuth resolution is 0.45 meters, but with higher sidelobes.

References

- [1] Curlander, J.C., and McDonough, R.N., Synthetic Aperture Radar: Systems and Signal Processing, Wiley, New York, New York, 1991.
- [2] Elachi, C., et al., "Spaceborne Radar Subsurface Imaging in Hyperarid Regions," IEEE Transactions on Geoscience and Remote Sensing, Vol. GE-22, 1984, pp 383-388.
- [3] Fitch, J.P., Synthetic Aperture Radar, Springer-Verlag, New York, New York, 1988.
- [4] Jarrett, B., "BYU SAR: A Low Cost, Compact Synthetic Aperture Radar," Master's Thesis, Brigham Young University, Provo, UT, 1994.